



Outdoor Accessibility Guidance

Supporting inclusive
outdoor access in the UK



About the guide

Thank you:

We would like to thank everyone who has supported and contributed to the development of this guidance. In particular, our thanks to the creators of the original Countryside for All guide and all the guidance that has supported the development of good practice and helped pave the way for this new work.

Published and directed by:

Paths for All: Rona Gibb, Richard Armstrong, John Duffy and Graeme Anderson.

Funded by:

Forestry and Land Scotland, Forestry England, Natural England, NatureScot, Paths for all and Sport Northern Ireland.

Writing and design:

Sensory Trust: Jane Stoneham (writing), Claire Francis (editing and proofing), Kathryn Jennings (illustrations), Stuart Spurring (design and layout), Wendy Brewin, Alice Whiting, Karen Marnie and Helen Rosevear (research).

Support, advice, technical input and images:

Aisling Irvine, Disability Sport NI ; **Alison Matheson**, NatureScot; **Andrew Mackintosh**, Natural England; **Craig Grimes**, Experience Community; **Drew Bennelick**, National Heritage Lottery Fund; **Emma Muldoon**, simplyemma; **Fiona Cunningham**, NatureScot; **Gemma Henry**, Able 2 Adventure; **Heather Smith**, National Trust; **Helen Townsend**, Forestry England; **Helene Mauchlen**, British Horse Society; **Jenny Wilson**, Forestry England; **Ismail Kholwadia**, Barnwood Trust; **Julia Matthews**, Forestry Commission; **John Cuthbertson**, Disabled Ramblers; **Keith Robertson**, MACS; **Kevin Lafferty**, Paths for All; **Liz Ellis**, National Heritage Lottery Fund; **Mike Petty**; **Mike Phillips**, White Horse Ecology; **Nick Johannsen**, Kent Downs AONB; **Phil Chambers**; Phil Chambers Consultancy; **Phil Whitfield**, Forestry and Land Scotland; **Peter Maxwell**, Forestry England; **Pippa Langford**, Natural England; **Rachel Parry**, Natural Resources Wales; **Susan Fulton**, MACS; **Tim Hawkins**, Forestry and Land Scotland; **Vyv Wood Gee**, for British Horse Society.

© copyright 2023

Image copyrights are reserved to the photographers identified in the text.

Credit for cover images: iStock.com/Dean Hindmarch (top) and Craig Grimes, Experience Community (bottom).

This guide will be updated regularly to respond to changes in the application of inclusive outdoor design and management. These will be managed by Paths for All and Sensory Trust.

Version 1.1 launched 18 April 2023.

Contents

.....

1. Introducing the guide	.1
What is an inclusive approach?	3
How to use this guide	7
2. Legislative framework	8
Anti-discrimination and equalities legislation.	8
3. Developing an inclusive approach	15
3.1 Commitments and policies	16
3.2 Training and professional development	19
3.3 Understanding the needs of your community	22
3.4 Access reviews to identify barriers	28
3.5 Action plan to resolve barriers to access	29
A. Guidance - Paths and routes	33
A.1 Planning paths and routes.	33
A.2 Path and route standards, grades and audits	42
A.3 Path dimensions	49
A.4 Reach	58
A.5 Views and viewing heights.	61
A.6 Path surfaces	65
A.7 Gradients and ramps	77
A.8 Steps.	80
A.9 Handrails	84
A.10 Gates, gaps and stiles	89
A.11 Boardwalks and bridges.	93
A.12 Cycle access	98
A.13 Horse riding.	102
A.14 Assistance dogs.	105
B. Guidance - Facilities and activities	107
B.1 Seating and shelter.	107
B.2 Toilets, showers and Changing Places	115
B.3 Car and cycle parking	119
B.4 Planning inclusive activities and events.	123

B.5	Children’s play	126
B.6	Picnic areas	131
B.7	Bins, temporary signs and furnishings	134
B.8	Health walks	135
B.9	Beach activities	140
B.10	Birdwatching	143
B.11	Fishing	148
B.12	Boating and water-based activities	151
C.	Guidance - Inclusive communication	153
C.1	Inclusive information for visitors	153
C.2	Guides and facilitators	161
C.3	Printed materials – clear and large print.	163
C.4	Designing with plain language	166
C.5	Designing with braille	169
C.6	Designing with symbol and pictorial communication . . .	172
C.7	Wayfinding	176
D.	Review tools	180
D.1	Reviewing a site or route using the Access Chain	180
D.2	Route review checklist	188
E.	Further guidance	189
	Access to the outdoors	189
	Key contacts	194
	Environmental organisations and diversity	198

1. Introducing the guide

This guide is designed to help make our outdoor places and spaces, routes and facilities more accessible, and outdoor experiences more inclusive, so they can be enjoyed by everyone. It is written for anyone managing land for public access and recreation, including land managers, community trusts, community groups and volunteers, access and recreation teams and owners. It will also assist anyone involved in designing outdoor spaces, planning outdoor activities and creating communication materials.

The guide updates and expands 'Countryside for All', which has been widely respected as a benchmark reference for improving access to the countryside across the UK since it was published in 1997. The Fieldfare Trust transferred the copyright of 'Countryside for All' to Paths for All in 2019. In 2020, Paths for All commissioned the Sensory Trust to review the original guide. There was overwhelming support for a comprehensive overhaul to reflect a wider diversity of people and landscape, and to bring it in line with the Equality Act 2010 and other relevant legislation. In 2021 Paths for All commissioned the Sensory Trust to develop this new version of the guide.

The guide is designed as a practical reference with techniques, tools and design details to help people meet, and where possible exceed, their legislative duties under the Equality Act 2010. Examples of good practice show how these principles have been implemented on the ground, and signpost to further information and expertise.

Guidance needs to keep up to date with new advances in working practices and new equipment and technologies. The intention is for this guidance to be updated on a regular basis.



Craig Grimes, Experience Community

Scope of the guide

The guide covers the UK and all types of publicly accessible land, from lightly managed and remote countryside to more intensively managed parks, community spaces, paths and trails. It recognises a wide diversity of legitimate uses, from a local walk or wheel, horse ride or cycle, to venturing out on a countryside trail or visiting a forest, garden or park.

The guide responds to the reality that many people with protected characteristics have less opportunity to enjoy the outdoors because of one or more barriers to access. Disabled people are often disproportionately impacted by physical barriers, such as gates, steps and uneven path surfaces. Therefore, there is particular emphasis on technical approaches to access improvements in this guide.

The guide uses two tools to review and plan access improvements:

- [Least Restrictive Access](#), an approach that aims for the highest standards possible for a particular piece of work.
- The [Access Chain](#), a tool that addresses access as a chain of events that starts from a person's decision to visit a site or route, through the journey, arrival and time spent there. It ends with the journey home. If any link in the chain is broken then the visit may be disappointing or never happen.

While the emphasis is on physical barriers and improvements, the guide covers some of the many intellectual and social barriers that need addressing to bring about inclusion.

A UK remit means that while many of the principles and practices can be shared, there are differences in legal frameworks between the individual countries. For example, in Scotland, the Land Reform (Scotland) Act 2016 (enacted 2003) confirms a right of responsible non-motorised access to most land and inland water. Whereas in England, Wales and Northern Ireland, access is generally restricted to public rights of way and their use is determined by specific route definitions.

This guide is designed to align with key guidance including '[By All Reasonable Means](#)', in England and Wales, the '[Outdoor Access Design Guide](#)', in Scotland and the '[Outdoor Places Guide](#)' in Northern Ireland.

Terminology

Many terms are used to describe the paths, routes and spaces that this guide covers. Unless otherwise noted, 'sites and routes' is used as a collective term throughout the guide.

There is also complexity in how we talk about diversity of people and preferred terminology changes over time. The language used in this guide aims to reflect current best practice.

The term 'characteristic' is used throughout this guide to reference one or more of the nine protected characteristics detailed in the Equality Act 2010. These are: age, disability, gender reassignment, marriage and civil partnership, pregnancy and maternity (employment only), race, religion and belief, sex and sexual orientation.

What is an inclusive approach?

In this guide, the term inclusive is taken to mean that a place or activity is usable by as many people as possible, regardless of their age, ability and protected characteristic(s). It is based on the principle that providing for the widest range of users creates better places, richer experiences and benefits everyone.

The approach relies on identifying barriers to access, who they affect and how to remove or mitigate them. While not everything can be made completely accessible to everyone, the ambition is to serve a diversity of interests and characteristics. As a result, when people arrive somewhere, with disabilities, young or old, from any faith or ethnic community, they can enjoy the experience on their own terms, independently or with family and friends.

Outdoor places and spaces are often populated by infrastructure that demonstrates what happens when you design for a supposed 'norm'. Paths, picnic tables, viewing heights, and visitor information panels can be accessible for some and inaccessible for others. The problem with averages is that they consistently move people to the fringes and the same people get overlooked.

By taking all needs into account, an inclusive approach achieves more value from the work and resources that have been invested and ensures legal obligations are met. Most importantly, it ensures that no one is unfairly or unreasonably excluded or restricted from enjoying the outdoors because of unjustified or unnecessary barriers.

An inclusive approach is underpinned by the Equality Act 2010 and related legislation. It is required by planning systems, expected by funders and increasingly supported by design guidance. Perhaps most importantly, making places, paths and routes and services accessible to people of all ages, abilities and characteristics has increasingly become recognised as simply the right thing to do.

.....
"As humans, we see others doing what we love – or what we want to love – and that inspires us. But lack of representation, of seeing others like ourselves, is one of the very basic reasons for lack of diversity, as well as an effect of it. As a child I would watch countless programmes fronted by David Attenborough, Steve Irwin, Chris Packham, Jane Goodall, Steve Backshall. I wanted what they had – the chance to explore the natural world and tell its stories. But I'd never been shown it was possible for someone who looked like me, or who had my life experience, to fill their shoes."
.....

Writer and activist Dawood Qureshi in the February 2022 issue of BBC Wildlife

What are the common barriers to access?

There is a collection of barriers that impact access for many people with protected characteristics. They vary in their significance for different people, and more exist than are listed here. Below are the ones that are commonly highlighted and which are addressed throughout this guidance:

- Physical barriers such as steep gradients, steps, uneven path surfaces, limited seating, resting places and excessive distances.
- Limited information about accessibility, poor wayfinding information and lack of information provided in alternative formats or languages.
- Lack of accessible toilets and changing facilities.
- Lack of confidence, not feeling welcome, fear over safety or getting lost.
- Lack of accessible transport and parking options, and costs of both.
- Lack of staff awareness of access needs.
- Limited range of activities and opportunities to use places in different ways.
- Poorly maintained environment.

Aiming for equality of experience

An inclusive approach doesn't mean the same experience for everyone, but the combination of individual experiences adding up to something equally great for everyone. People want to enjoy outdoor spaces and routes in their own way, whether on foot or horseback, cycling or using mobility equipment. Some want a relaxed stroll while others seek a challenging adventure over rough terrain. People should be able to enjoy a shared experience with a partner or friend, a family group, or a group outing without having to use separate routes, entrances and activities.

Access improvements made without fully considering the experiences on offer can be a waste of resources. For example, creating a wheelchair-accessible route that leads away from a site's popular highlights will make the route possible, but potentially isolating and not necessarily inviting. Encouraging a greater ethnic mix is unlikely to succeed if the interpretation is solely focused on stories that fail to embrace a wider cultural perspective.

Inclusive tools

The guide promotes two tools that help achieve an inclusive approach:

1) Least Restrictive Access (LRA)

The principle of Least Restrictive Access (LRA) is that all new work and maintenance repairs should aim to achieve the most accessible option. Least Restrictive Access is achieved by identifying the least restrictive option for a specific element, such as a gate or a piece of interpretation. The key is to look for opportunities to improve accessibility and reduce restrictions rather than assuming there are sites and routes where options do not exist and where the onus is on justifying lack of action.

Examples of Least Restrictive Access in practice

A gap is less restrictive than a chicane or bollard, which is less restrictive than a self-closing gate, which is less restrictive than a stile. So, when a stile is removed, the first option is to seek to replace it with a gap. If this is not an option, it is replaced by a chicane or bollard, and then a gate that is as accessible to as wide a range of people as possible. All options must be compliant with the British Standard for Gaps, gates and stiles (BS 5709:2018).

2) Access Chain

The Access Chain was developed by the Sensory Trust to ensure that access planning relates to all parts of an outing. The Access Chain starts with the first step of making a decision to go somewhere; followed by the journey, then the experience itself, and ending with a safe return home. If any link in the chain is broken then what should be an enjoyable day out, can turn to disappointment, or may never happen. It is a good basis for reviewing or planning access.

Visitor experience

Decision to visit

Journey and arrival

On-site experience

Return home



Examples of things to consider

- Information about access and accessible facilities
- Accessible formats and choice of languages available
- Promotion and publicity present a welcoming and inclusive image for all visitors
- Good publicity with targeted distribution

- Public/community transport
- Accessible car parking/drop off
- Welcoming entrance with orientation information
- Free entry for carers/supporters
- Inclusive facilities eg toilets, changing facilities, cafes

- Routes and signposting for all abilities
- Inclusive events planning
- Accessible information and interpretation
- Inclusive facilities eg toilets, changing facilities, cafes
- Inclusive visitor experiences available to a diverse audience

- Public/community transport
- Accessible car parking/pick up
- Feedback and involvement encouraged
- Activity packs for groups - accessible formats and choice of languages available

More information about the Access Chain: www.sensorytrust.org.uk/resources/guidance/access-chain-an-inclusive-design-tool

Access standards

In the absence of statutory accessibility standards for most access to the outdoors, it is an important role of this guide to provide recommendations that can serve as benchmarks for access improvements. Any statutory standards associated with the building regulations or standards in each UK country should be used where they apply.

The recommended standards in this guide are based on the following principles:

- They do not define people, or their characteristics, but instead the physical conditions that will best serve the widest diversity of users and uses.
- They are intended to serve as a minimum standard, recognising that exceeding them will make a site or route more usable and accessible to more people.
- They should be applied with sensitivity to the local character and conditions of the site or route in question.

With existing access standards, some user needs receive more attention than others. For example, it is hard to find access information that relates to people with restricted growth or dwarfism, while hidden disabilities are only beginning to be addressed more widely. More research and experience will inform these areas. In this guide, we have widened the scope of our recommendations as much as possible, while recognising that this subject area is constantly evolving.

How to use this guide

This guide is designed to follow the process of developing inclusive policies and commitments to reviewing existing sites and routes and implementing access improvements. However, it is also intended to serve as a quick reference for people needing information about a specific topic.

It is organised in the following way:

Section 1 (this section) outlines the background to the guide, what we mean by an inclusive approach, and the underlying tools and standards that it is based on.

Section 2 is a summary of the main legislation in the four UK countries.

Section 3 outlines the steps involved in an inclusive approach to access improvements, from developing policies and plans to reviewing and implementing the work.

Sections A: paths and routes, B: facilities and activities, and C: inclusive communications contain guidance sheets with technical information, recommended standards and examples of good practice for specific elements.

Section D has review tools for assessing sites and routes.

Section E has links to other organisations and sources of guidance.

Layout

All dimensions are in millimetres (mm) unless otherwise indicated.

Gradients are expressed in ratio and percentage.

2. Legislative framework

Anti-discrimination and equalities legislation

People, communities and organisations that own and manage outdoor places in the UK have legislative duties not to discriminate against and make ‘reasonable adjustments’ for people with protected characteristics. Some legislative duties are UK-wide, and others are specific to each of the four UK countries.

The Equality Act 2010 (England, Scotland, Wales)

The Equality Act 2010 (hereafter referred to as ‘The Act’) is the key piece of anti-discrimination legislation in England, Scotland and Wales. In Northern Ireland, The Act does not apply and there are individual pieces of anti-discrimination legislation, including the Disability Discrimination Act (DDA).

In England, Wales and Scotland the DDA and Race Relations Act are no longer in place and have been absorbed into the Equality Act along with over 100 individual pieces of legislation.

The Act protects individuals from discrimination in relation to nine ‘personal characteristics’. These are age, disability, gender reassignment, marriage and civil partnership, pregnancy and maternity (employment only), race, religion and belief, sex and sexual orientation.

The Act identifies ways in which it is unlawful to treat someone, including direct and indirect discrimination, harassment, victimisation and failing to make a reasonable adjustment for a disabled person.

Reasonable adjustment

The concept of reasonable adjustment was introduced by the DDA and is now part of The Act. It places a responsibility on organisations to promote equality, encourage greater participation and eliminate discrimination against disabled people. What is considered reasonable depends on the specific situation and the results of case law, but typically involves:

Changing the way things are done. Reviewing and altering policies and routine practices to improve accessibility and reduce discrimination.

For example: a review of practices for installing new gates reveals the need to change the design specification to take account of the increased size of mobility scooters and to change the opening and closing mechanisms so they are easier to reach and use.

Changing physical features. Modifying a route to overcome barriers and to maximise accessibility for the widest range of people.

For example: improving the surface of a route and adding more frequent

seats and resting points supports greater use by people with reduced stamina.

More information on Equality Act 2010: www.gov.uk/guidance/equality-act-2010-guidance

More information on reasonable adjustment: www.equalityhumanrights.com/en/multipage-guide/using-service-reasonable-adjustments-disabled-people

Protected characteristics

Protected characteristics help identify people who tend to be impacted by barriers to access but these are not distinct and separate groups of people within the community. Diversity weaves its way through families, groups of friends, couples and individuals. Many people have more than one protected characteristic and intersectionality is an important framework that recognises how these characteristics combine and overlap.

More information on protected characteristics: www.equalityhumanrights.com/en/equality-act/protected-characteristics

More information on intersectionality: www.internationaldisabilityalliance.org/intersectionalities and www.womankind.org.uk/intersectionality-101-what-is-it-and-why-is-it-important/

Social and economic disadvantage

Socio-economic disadvantage is not identified as a protected characteristic in the Equality Act. Nonetheless, it significantly reduces people's opportunities to explore the outdoors more widely.

There is a complex relationship between socio-economic status and some of the protected characteristics such as age, gender, ethnicity and disability that is important to acknowledge. By addressing or considering socio-economic status the opportunity arises to address some of the deeper needs of those protected by the nine characteristics.

In Scotland, the '[Fairer Scotland Duty](#)' places a requirement on certain public authorities to do more to tackle persistent inequalities of outcome caused by socio-economic disadvantage.

This guidance, therefore, includes it as an aspect to strive to address within the context of wider diversity.

Public Sector Equality Duty

The Public Sector Equality Duty requires public authorities to consider how their policies and decisions impact people who are protected under the Equality Act 2010. This includes the elimination of unlawful discrimination, advancing equality of opportunity and fostering good relations between people with protected characteristics. The duty is often addressed through the development of an Equality Impact Assessment.

More information: www.equalityhumanrights.com/en/advice-and-guidance/public-sector-equality-duty

Equality Legislation (Northern Ireland)

The Equality Act 2010 does not apply in Northern Ireland where there are individual pieces of anti-discrimination legislation. The Disability Discrimination Act (DDA) is still in place.

[Section 75 of the Northern Ireland Act 1998](#) places a duty on public authorities to ensure that equality of opportunity and good relations are promoted between persons of different religious belief, political opinion, race, sex, disability, marital status, dependency and sexual orientation. It requires that these principles of equality are central to policy making and service delivery.

[The Rural Needs Act \(Northern Ireland\) 2016](#) requires district councils and other public authorities to have due regard to rural needs when developing, adopting, implementing or revising policies, strategies and plans and when designing and delivering public services.

There are ambitions to change the practices of government and public authorities so that equality of opportunity and good relations are central to policy making and service delivery. The Section 75 statutory duties aim to encourage public authorities to address inequalities and demonstrate a measurable positive impact on the lives of people experiencing inequalities. Its effective implementation should improve the quality of life for everyone in Northern Ireland.

A More Equal Wales

In Wales, public bodies play an essential role towards contributing to fairness and equality through the services they provide. There are a series of duties which play their part in enabling public bodies to consider opportunities and apply their duties. Public bodies are required to consider equality through their decision-making processes. Public bodies are required to address the following:

- Socio-economic Duty. When making strategic decisions, such as deciding priorities and setting objectives, consider how these decisions can reduce inequalities of outcome associated with socio-economic disadvantage. Relevant public bodies are encouraged to be able to evidence a clear audit trail for all decisions made under the Duty.
- Public Sector Equality Duty. Assess the likely impact of proposed policies and practices on the ability to comply with the general duty and the particular impacts on people with protected characteristics. Public bodies must publish reports of the assessments where they show a substantial impact (or likely impact) on their ability to meet the general duty. This has become known as an EIA (Equality Impact Assessment).
- Wellbeing of Future Generations Duty. Understand how public bodies can make the best contribution to their well-being objectives in their governance, policy and through the decisions that they make. There is no specific requirement to carry out well-being impact assessments, but public bodies can choose to do so.

More information: www.gov.wales/more-equal-wales-mapping-guide

Public access legislation

The Countryside Rights of Way (CRoW) Act 2000 (England and Wales)

The CRoW Act improved public access in England and Wales through a statutory right of access on foot to mountain, moor, heath, downland and registered common land. When introduced in 2000, CRoW gave new powers, duties and responsibilities to highways authorities involved in countryside access management.

Local highway authorities are required to prepare and publish a Rights of Way Improvement Plan (RoWIP) and to review it not less than 10 years after publication. In developing the Plan, the requirements of the Equality Act 2010 must be taken into consideration.

When planning improvements and new structures, highway authorities must consider the requirements of the Equality Act 2010 and aim to make them as accessible as possible. For example, replacing stiles with gaps or gates as much as possible and normally to BS 5709:2018 requirements. Section 147ZA is a specific section of the Highways Act 1980 that gives local authorities powers to enter into agreements with landowners to undertake improvements to gates and stiles to make a footpath or bridleway more accessible for disabled people.

Local Access Forums were established under the CRoW Act. In giving advice, they are required to consider the access needs of people who experience barriers to accessing greenspace. This includes disabled people, ethnic minority groups, people on low incomes and visitors from outside the local area, who are likely to have particular access needs and concerns.

More information about CRoW: www.gov.uk/guidance/open-access-land-management-rights-and-responsibilities

The Land Reform (Scotland) Act 2003 (Revised 2016)

The Land Reform (Scotland) Act established a statutory right of responsible access to most areas of land and inland water in Scotland. The right to responsible access does not apply to most vehicles, with the exception of, for example, motorised wheelchair and mobility scooter users. Access rights in Scotland come with responsibilities for both access takers and land managers, which are fully explained in the Scottish Outdoor Access Code (the Code).

The three main principles of the Code are to:

- Take responsibility for your own actions.
- Respect the interests of other people.
- Care for the environment.

All Access Authorities (the 32 Local Authorities and the two National Parks) also have a duty to develop a [Core Path Plan](#).

More information about the Act and the Code: www.outdooraccess-scotland.scot/

Planning, design and construction legislation

Building Regulations and Building Standards

The Building Regulations in each UK country provide statutory minimum standards for new and adapted design and construction of virtually all buildings. They apply primarily to buildings but include areas that form part of an entrance to a building.

The building regulations or standards include technical guidance that identifies minimum standards to ensure a wide range of people can access buildings and their facilities. Compliance with the relevant technical guidance will demonstrate that care has been taken to make development accessible for disabled people, but it does not assure compliance with the broader requirements of the Equality Act.

There are no statutory accessibility standards for most areas of landscape. Facilities such as visitor centres and cafés, and landscapes associated with the entrances of buildings, are likely to be covered by Building Regulations or in Scotland by the Building (Scotland) Regulations 2004. Even where these do not apply, their associated guidance provides a valuable reference.

British Standard BS 5709:2018 Gaps, gates and stiles

The key principle of the British Standard is that any human-made impediments on a public right of way must consider what will be the Least Restrictive Access. So, whenever possible it recommends that a gap should be introduced into the fence line before a gate and only in very exceptional circumstances should a stile be used. It is important to note that this guide does not recommend the use of stiles in any circumstance. In Scotland, the use of stiles does not comply with the land reform (Scotland) legislation.

References to the British Standard are made throughout this document. Due to copyright, the full standard cannot be made available online. A simplified version has been created called 'Understanding the British Standard for Gaps, gates and stiles' and can be found at www.centrewire.com/wp-content/uploads/2019/09/Pittecroft-Trust-BS5709-2018-explained.pdf The full version can be purchased at knowledge.bsigroup.com/

Historic landscape legislation

It is important to note that the Equality Act 2010 does not override conditions associated with planning, listed building legislation, scheduled monuments and inclusion on registers and inventories of sites of special historic interest. However, Defra's Planning Policy Guidance Note (PPG 15) highlights that "with a proper approach it should normally be possible to plan suitable access for disabled people without compromising a building's special interest".

More information:

Historic England's Register of Parks and Gardens of Special Historic Interest in England www.historicengland.org.uk/advice/hpg/compliantworks/equalityofaccess/

Historic Environment Scotland's Inventory of Gardens and Designed Landscapes www.historicengland.org.uk/listing/what-is-designation/registered-parks-and-gardens/

Cadw's Registered Historic Parks and Gardens www.cadw.gov.wales/advice-support/placemaking/legislation-guidance/registered-historic-parks-and-gardens

The Northern Ireland Environment Agency's (NIEA) Register of Parks, Gardens and Demesnes of Special Historic Interest www.communities-ni.gov.uk/publications/register-parks-gardens-and-demesnes-special-historic-interest

Construction (Design & Management) Regulations 2015 (CDM 2015)

The CDM Regulations are designed to protect the health, safety and welfare of people working in, or who may be impacted by, all types of construction projects, from new build to repair and maintenance. The regulations outline steps that must be taken to ensure risk is effectively managed throughout construction projects. Health and safety responsibilities and project duties are divided between 'duty holders', eg. the clients, designers, contractors and construction staff.

The process of risk management must reflect the diversity of people. This can relate to how CDM information is shared so it is accessible to the design and construction team. It also means considering potential risks to different users. For example, the heightened risk to blind and partially sighted people from changing path layouts or introducing obstacles, or the accessibility of an alternative route if a section of trail is closed for tree works.

More information: www.hse.gov.uk/construction/cdm/2015/index.htm

Planning (Scotland) Act 2019 Open Space Strategy

Planning authorities in Scotland are required to develop an Open Space Strategy (OSS) for the development, maintenance and use of green infrastructure in their area. The OSS includes auditing existing open space as well as assessing future requirements. The Act also requires a Forestry and Woodland Strategy and a Play Sufficiency Assessment.

More information: www.nature.scot/professional-advice/placemaking-and-green-infrastructure/open-space-audit-and-strategy-oss-hub

Health and safety and risk assessments

The Management of Health and Safety at Work Regulations (2006) places a legal duty to identify and manage risks associated with any works. This applies to employers, employees and anyone involved in works, such as contractors and volunteers.

Risk assessments are used to identify risks and to assess how they can be reduced or eliminated. They should include consideration of safeguarding in relation to activities where the safety of participants must be ensured. It is

essential that the systems you use are inclusive and give adequate thought to a diversity of people.

More information at the Health and Safety Executive: www.hse.gov.uk

3. Developing an inclusive approach

Inclusive practice relies on a commitment to being open to change and positive attitudes, as well as practical changes on the ground. Relevant policies and investment in suitable staff and volunteer training can demonstrate an organisation's commitment towards being more inclusive and improving access. Community engagement is key to engaging a wider diversity of local people and visitors. Access reviews and action plans are instrumental for assessing current sites and routes and identifying the most effective access improvements.

The following sections detail how to follow this approach:

1. Commitments and policies.
2. Training and professional development.
3. Understanding the needs of your community and stakeholders.
4. Access reviews to identify barriers (not just physical).
5. Action plans to resolve barriers to access.

3.1 Commitments and policies

An organisation's commitment to an inclusive approach is reflected through its policies, staff and volunteer attitudes and a culture of listening and being open to change. Even if large scale access improvements are not possible, investing in people and organisational change is one of the most important things you can do.

A policy is a commitment to specific aims while a strategy outlines how these aims will be achieved. It is important to develop these with people who bring diverse perspectives and needs. For public sector organisations, these policies and strategies can help meet duties in relation to an [Equality Impact Assessment \(EqIA\)](#).

Community groups and voluntary organisations may find it helpful to refer to the policies of local authorities or other organisations.

A commitment to an inclusive approach can be reinforced by a statement on your website, for example as shown by South Downs National Park at www.southdowns.gov.uk/national-park-authority/our-people/equity-diversity-and-inclusion/



What does inclusive practice look like?

- ▶ A commitment to inclusive practices is integrated into all policies, not just equality and diversity ones.
- ▶ There is an active commitment to increasing diversity in trustees, stakeholders, staff and volunteers.
- ▶ Diversity is represented through promotion and communications, adding voice to diversity advocacy.
- ▶ There is a clear no-tolerance policy to discriminatory behaviours inside and outside the organisation and an effective response to complaints.

Access policy development

An access policy provides the basis for inclusive working practices. It may be developed for an organisation or a specific site or route. It is important that all staff engage with drafting, application and regular review.

A policy should cover the following three components:

Why there are key reasons for improving access. For example, to increase the frequency of visits by under-represented groups.

What a clear statement of what a policy hopes to achieve. For example, to **ensure** that people have choice over where, when and how they will be able to enjoy the outdoors.

How key actions will be pursued. These may include:

- What resources will be available to achieve the aims of the policy?

- Plans to consult with current users and non-users of paths, sites and facilities.
- Commitment to train staff, volunteers and people from partner organisations and associated groups.
- Commitment to monitor and evaluate the implementation and effectiveness of policies and make adjustments where necessary.

It is important to invite feedback on a draft policy with a representative range of organisations and individuals (see Section E).

Equality Impact Assessment (EqIA)

An Equality Impact Assessment evaluates the inclusiveness of an organisation's policies and services. It is a systematic and evidence-based tool that considers the likely impact of working practices on different groups of people. It relates principally to the Public Sector Equality Duty, but it can be a valuable tool for any organisation to use. If used properly an Equality Impact Assessment should be a working document that identifies barriers and exclusions from the concept stage to evaluating the finished project, service or policy.

In England, the completion of an Equality Impact Assessment is no longer a legal requirement, but it is a well-established means of demonstrating due regard to the Public Sector Equality Duty (PSED) which is required by law. The assessments are still widely used by the public sector. More information: www.gov.uk/government/publications/equality-impact-assessments-2010

In Scotland, the Public Sector Equality Duty places a legal requirement on public bodies to undertake and publish Equality Impact Assessments. More information: www.nature.scot/doc/naturescot-equality-impact-assessments

Similarly in Wales where substantial impacts are foreseen from proposed policies and practices. More information: www.ombudsman.wales/wp-content/uploads/2022/06/Equality-Impact-Assessment-Policy-and-Procedure.pdf

In Northern Ireland, completion of an Equality Impact Assessments is a legal requirement under race, disability and gender equality legislation. More information: www.equalityni.org/Employers-Service-Providers/Public-Authorities/Section75/Section-75/What-is-an-EQIA



Examples of good practice

Developing an access policy, Lancashire County Council

- ✓ To explore local needs and views, the Lancashire County Council Pilot Project shared a questionnaire with disabled individuals and disability groups, including those in the Lancashire Disability Information Federation Directory, outdoor groups eg The Ramblers and representatives of the Lancashire Access Forum and Public Rights of Way Forum. Many of the respondents participated in future workshops. The Project consulted in the following ways:

- ✓ The draft access policy document was placed on the council's countryside and access web pages.
- ✓ Copies of the draft policy were sent to stakeholders who had responded to the earlier letter and all countryside and rights of way staff within the council.
- ✓ A presentation was made to the Disability Forum – made up of representatives from a wide range of disability groups – followed by a short discussion on some of the issues raised.
- ✓ A copy of the draft policy was sent to all members of the Lancashire Local Access Forum. A presentation was given and some of the issues raised were discussed in the Lancashire Local Access Forum meeting.
- ✓ A workshop was organised and everyone who had been consulted on the draft policy document was invited.

The consultation raised issues for further discussion and the Lancashire Local Access Forum was asked to advise on how best to consult further. In addition, a second workshop was organised to give a further opportunity to discuss issues face to face.

TCV Building Roots project is opening up volunteering opportunities to Syrian refugee families living in Scotland as a way of connecting them with Scottish heritage and greenspaces close to where they live. www.tcv.org.uk/about/building-roots-community/

3.2 Training and professional development

Sustaining an inclusive approach relies on building skills, confidence and awareness in staff and volunteers. There are often individuals who take a lead in accessibility work, but the approach needs to be supported by all members of the organisation or group so that it is reflected in all aspects of work. Implementing improvements on the ground may have limited impact if there is no financial commitment to maintenance, for example, or no public information so people are unaware that the changes have been made.

It is important to keep in mind that some of the most effective learning arises from experiences and encounters in day-to-day work. By sharing these experiences within the team, everyone can learn from what goes well and not so well.

Formal training can be very important for gaining new skills and knowledge, but opportunities will inevitably be limited because of time and budget. Informal ways of widening perspectives could include:

- Opening up participation in public activities and events to staff and volunteers who would not normally be involved.
- Visits to projects and sites to share good practice and discuss ways to overcome challenges.

Training in inclusive practice

Specific inclusion training is important but so is ensuring that the principles carry into other areas of training. From Health and Safety to outdoor learning and visitor management, all areas of the organisation should adopt an inclusive approach.

Induction training for new staff and volunteers is an important scene-setter and demonstrates organisational commitment. New employees and volunteers need to know that at the most senior level an inclusive approach is at the heart of the organisation. Induction training should inspire people, give them permission and motivation to take diversity more seriously.

Training in inclusive practice is likely to cover the following:

- Implications of Equality Act 2010 and other relevant legislation.
- How to involve and engage with local people and under-represented groups.
- Access standards, management zones and access audits.
- Access Plans and the planning process.
- Accessible information and communication.

Focusing training on outdoor experiences helps teams relate the training to their own work and to appreciate practical ways they can help ensure everyone can have a great time. It is important to prioritise teams with direct responsibility for managing the visitor experience, so particularly rangers,

wardens, activity leaders, and education, retail and communication teams.

It is essential that training delivery is accessible, with careful consideration of the accessibility of the venue, training materials eg PowerPoint presentations and handouts and practical activities. Attendees should have the opportunity to say what requirements they need to attend with enough time built in to make the adjustments.

Practical exercises help teams identify and resolve issues themselves, with the idea that this will give them the tools to continue the approach within their work. For larger organisations, this is an opportunity to involve people in delivering the training who can represent the perspectives and experiences across the range of protected characteristics.

Language and communications training

Training enables staff and volunteers to appreciate the diversity of language and communication methods and learn more about how to best support them.

It is important to note that Welsh and English now have equal status as languages in Wales while in Scotland, the profile of Gaelic is increasing. It may not be realistic to expect staff and volunteers to become proficient in a language that is new to them, but even being able to welcome or greet visitors by using a few basic words will be appreciated.

British Sign Language (BSL)

British Sign Language (BSL) is the preferred language of over 87,000 Deaf people in the UK, for whom English may be second or third (www.bda.org.uk/help-resources/). It is now recognised as an official language, making it Britain's fourth indigenous language after English, Welsh and Scottish Gaelic. In Northern Ireland, both BSL and Irish sign language are used.

Investing in BSL training will welcome and encourage greater involvement of D/deaf people as visitors, volunteers and staff. Depending on the size of your organisation, it can be good practice to have a member of staff trained as a sign language interpreter to help visitors in visitor centres, or on guided walks and at events.

Training in Stage 1 BSL will give sufficient skills to hold basic conversations with BSL users. While this doesn't replace the need to hire BSL translators for special events, it can be an effective approach to increasing the welcome for people who are D/deaf and hard of hearing. Training in Stage 2 BSL will enable staff to converse more fully and shows great recognition of BSL as a language.

Sign and symbol communication

Symbol-based communication methods, such as Makaton and Widgit, have been developed primarily for people with learning and communication difficulties, their teachers, friends and families.

Makaton uses a simple form of sign language that is used as an aid to the spoken word and a set of symbols to accompany the signs. It is also

increasingly used as a form of early communication with babies and toddlers. The Widgit symbols set is used to support text. Both Widgit and Makaton are used widely in specialist schools across the UK.

Training in the basics of Makaton signing can help staff and volunteers widen their communication with the public and the use of Widgit symbols for those responsible for developing communication materials, such as leaflets and interpretation materials (see Section C.2).

Braille

Braille is an example of a communication system that is used by a relatively small number of blind people, but for these individuals, it can be a primary means of independently accessing written information. Training in the basics of these communication methods will help when using it in your visitor information and judging where and when it will be most useful.



Examples of good practice

A multilingual project at Manchester Museum harnesses the diversity of languages and experiences of the staff team by reflecting the linguistic diversity of the city; Manchester has over 200 languages in use. Even if this is beyond the scope of your organisation it may open up ideas for collaborating with initiatives that may exist in your area.

More information: www.multilingualmuseum.wixsite.com/multilingualmuseum

The [living-language-land project](#) explores how endangered and minority languages reveal different ways of relating to land and nature. The collection of words and recordings is freely offered for people to use and it is an opportunity to incorporate into training as well as wider activities.

Paths for All has developed signage and techniques to make outdoor spaces more welcoming and accessible to people living with dementia. Some of these approaches are highlighted in their national demonstration site www.pathsforall.org.uk/community-paths/cmp-the-national-demonstration-site

Sensory Trust has guidance and advice available on a range access and inclusion topics to support professional development www.sensorytrust.org.uk

3.3 Understanding the needs of your community

Users and patterns of use

An essential starting point for planning access improvements is to understand how your site or route is currently used, by who, who is missing and why. Developing closer links with your surrounding communities – residential areas, schools, care communities and so on – will help highlight likely patterns of use and accessible path networks.

It is equally important to consider who is not visiting and the reasons why. This is more challenging, but it will help you understand what barriers are impacting people. It should explore how different people need to use a route to get to work, school or the local pub, or how they would like to use a site or route recreationally.

It is also important to involve staff and volunteers who have regular contact with visitors as they often have valuable knowledge of access issues and good ideas for improvements. Unfortunately, they are often the least consulted when planning access improvements.

Surveys, desk research and observations will play an important part in gathering information. However, it is only by asking people about their needs, interests and aspirations that you will gain meaningful insights into how they use a site or route and what barriers impact them.

Community engagement

Fostering a positive relationship with your community is key to improving access. It will help you understand the barriers to access that are impacting people and what improvements would make greatest difference. It can help your community learn more about your plans and it may inspire some to get more involved.

Community engagement can focus on a specific issue over a short timeframe or may be part of longer-term relationship building. It can range from a simple walk-and-talk with a local group and observing patterns of use, to a structured programme or co-design process. It is important to be transparent from the start about what you are hoping to achieve.

Small organisations and community groups may have limited resources to commit to consultation and Section E has organisations and sources of guidance that may help. Another option is to identify local sites and routes where access improvements have been successfully implemented and where an organisation may be willing to share information.

Community engagement also helps you meet duties under the Equality Act 2010. In Scotland this is supported by the [Community Empowerment Act](#) and [National Standards for Community Engagement](#) and in Wales by the [Wellbeing of Future Generations \(Wales\) Act](#).

Co-design

Co-design is a collaboration between community individuals or groups and an organisation. It implies a closer working relationship and equal power of decision-making than is typical in community engagement and consultation. It can relate to a wide range of work, for example planning an access improvement, designing some new interpretation or working on policies and strategies.

Key ingredients of successful co-design include:

- Expertise gained through lived experience is valued on equal terms with more formal qualifications and practitioner skills.
- Decision-making power is shared equally.
- The design process is inclusive with careful attention to the accessibility of meeting venues, design techniques and communication.

Planning community engagement

- Identify your aims, what you hope to achieve.

The clearer you are about why you are involving people and what you hope to achieve, the better your results will be. Be open about who you are, what your plans are and why you are asking people to get involved.

Be clear about anything that may limit options for change such as safeguarding an archaeological boundary or protecting a bird nesting site. Inform participants how their feedback will be used and how they will be kept informed about progress.

- Consider delivery requirements.

This relates to any targets that must be met, for example, to deliver the work by a specific date or to consult with certain numbers and groups of people. This often relates to funding requirements. It is important to consider if timescales are realistic.

- Identify your community.

Gather any information you already have about how your site or route is currently used, consider whether this is mainly the local community or people from further afield.

Engage existing users who know your site or route well and can give informed feedback. However, involve potential users too otherwise you will only learn from people who have already decided their needs are met to some extent. People who don't currently use your site or route, but who would like to, can reveal important information about barriers to access.

- Consider time, money and staff.

Adequate resourcing is key to successful community engagement. It is important to allocate a sufficient budget to cover community costs, from venue hire to time and expenses for participants, as well as staff time, specialist advice and tools such as survey software. Clarify who will facilitate the

community engagement. In-house facilitators may have good knowledge of the site or route, what is being addressed and why, while external facilitators may be more objective and may elicit more direct and honest responses from consultees.

Professional input can lend specialist insights, for example about heritage and conservation value which are important considerations when identifying access improvements. This may include historians, local authority officers, engineers, conservation professionals, access and inclusion specialists and landscape architects.

- Be inclusive.

Choose accessible venues and timings for workshops and meetings and inclusive techniques for inviting feedback. Reach out to individuals and networks who can connect you with people who have limited experience with the site or route in question but who may be interested.

- Keep people informed.

A common criticism from people who have given time to share their views is that they never heard what happened as a result of their contribution. You therefore need to factor in a process for keeping people informed as to the outcomes of the consultation. Investing in these relationships makes it more likely that people will help you with further consultation, as potential volunteers or as advocates who support you and promote your work in the community.

- Document the process.

Ensure that all decisions are recorded along with who was consulted and what action was taken. This helps if there is a staff change or if decisions are challenged at a later date.

Table 3.3a Types of community engagement

Who to involve	Potential outcomes	How to involve people
<p>Local communities</p> <p>Community groups, walking, cycling, riding groups, retirement communities, schools, day centres, healthcare centres, youth groups.</p>	<p>Information about the local area, how people use a site or route now and how else they might wish to.</p> <p>Identifying who else may be interested in being involved in consultation or an activity, as volunteers or in using a site or route.</p> <p>Identifying community groups, organisations and individuals who can work with you as community connectors and facilitators.</p>	<p>Obtain links from local authority community and outdoor access teams. Ask communities to spread the word among their networks.</p> <p>Set up focus groups and publicise through local and social media.</p> <p>Go to the community too, using events and venues where they feel most comfortable, rather than just expecting them to come to your events and meetings.</p> <p>Online and on-site surveys to find out how people use a site or route now and how else they might use it.</p> <p>Workshops and conversations in community venues where people feel most comfortable.</p> <p>Online meetings or online surveys to capture people who can't be there in person.</p> <p>One-to-one conversations and surveys.</p>

<p>Existing users</p>	<p>Who is currently using a site or route, why they are visiting and how they use it.</p> <p>How well these people reflect the local community in terms of diversity and who is missing.</p> <p>Identifying current users or types of use that are difficult to integrate, eg bicycle use and horse riding.</p> <p>Highlighting when and how the place is used.</p>	<p>Plot these communities on a map and make contact.</p> <p>Consult and engage with people to see how they would like to use the site or area.</p> <p>Visitor surveys, online or using existing volunteers and staff.</p> <p>On-site surveys on different days, times of day and seasons.</p> <p>Consult with local people, ensuring that all users are included.</p> <p>Electronic visitor counters for general visitor numbers. Place these strategically to get more idea of how people use different areas.</p>
<p>Non-users</p>	<p>Identifying who else might want to use the site or route, how and why.</p> <p>Highlighting how this relates to different types of use, ability, interest and age range.</p>	<p>Distribute a questionnaire survey online and locally (and more widely for sites that attract tourists).</p> <p>Consult and engage with local groups and networks who connect you with people.</p> <p>Work with community and group leaders to start conversations.</p> <p>Contact national organisations and invite them to involve their members.</p> <p>Organise simple, fun gatherings to attract new people and act as starting points.</p> <p>Use sensory mapping as a tool to encourage people to explore the site or route.</p> <p>Refer to existing survey information, eg MENE survey in England.</p>



Examples of good practice

Saughton Park, Edinburgh, Scotland is an example of how the restoration of a place can be an important focus for community engagement. This project reached some of the more vulnerable people in the surrounding communities, addressing health inequalities and supporting community integration. There is active involvement of people with mental health problems and learning disabilities, refugee families and newcomers to the area.

“The project has shown the wealth of talent and energy that exists within communities, even where there are challenges of deprivation and lack of income. It shows how parks can become welcoming places for all sections of society. But it also shows the need for constant care and attention to keep people engaged and enthusiastic and the importance of making sure local people have a real say in the park’s future.” www.heritagefund.org.uk/sites/default/files/media/attachments/Saughton%20Park%20study.pdf

The Place Standard Tool has been developed by the Scottish Government to provide an easy way of engaging people with assessing the quality of a place. The tool is available on the ‘Our Place’ website, along with case studies and other community engagement materials.

More information: www.ourplace.scot/toolbox

3.4 Access reviews to identify barriers

An access review identifies barriers to access and what improvements would benefit the widest range of visitors. It is important to work with disabled people and people with other protected characteristics to ensure there is support for the work and it delivers real benefits.

It is possible to undertake a small-scale or basic review as an in-house exercise, but unless you have staff members who are skilled in this area it is advisable to appoint someone with the relevant experience and skills.

Note that the terms audit and review are both widely used, and they are used interchangeably in this guide.

Audit and review tools

There are two types of review identified in this guide:

- Site review. This is recommended for a destination, such as a country park, where there are facilities and activities to consider as well as routes. It can also be useful for a route network, or even a specific route, where it can help look at wider connections and barriers. A site review tool based on the [Access Chain](#) is provided in Section D.1.
- Route review. This assesses the specific characteristics of a route, such as surfaces, widths and gradients. It is often carried out as the result of a site-wide review, or a planning exercise that has identified which routes should be prioritised for review. Route review is covered in Section A.2.

3.5 Action plan to resolve barriers to access

Prioritising access improvements

When planning physical access improvements, and with limited budget, it is important to identify the following:

- Which barriers can be removed, for example simply leaving a gap rather than retaining a restrictive kissing gate.
- Which barriers can be avoided, for example by creating an alternative route to bypass steps.
- Which barriers can be mediated by other actions for example adding seating alongside a gradient or replacing a tricky stiff bolt with an easy-access latch on a gate.
- Which barriers are most significant and a priority for action for example an area of uneven path, steps, stiles and steep gradients.

Implementing the work

When implementing any work it is important to consider the following:

- All new work meets the relevant recommended standards and takes into account the Equality Act 2010.
- New work matches available budget and skills.
- The best choice of materials and construction techniques in relation to local sourcing of materials and people skills.
- Environmental impact of materials, for example sustainability and longevity of materials and prioritising recyclates and porous surfaces.
- Maintenance implications of different materials and construction techniques.

Promote widely

Access improvements will have less benefit if people don't know about them. This relates particularly to people who may need the reassurance of knowing these changes have been made before committing to a visit.

Evaluate the work

This can feel like an onerous step after all the hard work of implementing access improvements, but it is important. It will help you identify what worked well, and what could have been done better, and these will be important learnings for future work.

Use surveys and consultation sessions to evaluate the effectiveness of the work, ideally having involved a diversity of people in planning and managing the work. Use the results to influence the ongoing improvement programme. Consider collecting data on how visitor numbers and diversity have increased

after you carry out improvements, this could help justify future investment. Review the process from the beginning every three to five years. Consider changes such as usage patterns, demographics, budget changes, funding for special types of work and changes in the way some routes are valued by people you consult with.

Maintenance

The maintenance programme is an opportunity to improve access by applying the principle of Least Restrictive Access to meet or exceed the standards where possible. This approach can gradually improve the quality of routes over time. Improved routes may become more popular, and this will be highlighted in future evaluations, especially if an Equality Impact Assessment (EqIA) is maintained as a working document to monitor progress and need for future improvements.

Examples of actions

This example of an action plan shows how priority areas of focus can be identified and matched with corresponding actions. Timescales and costs are useful additions. The example below can be used as a basis to build action plans for other sites and routes.

If you are developing an Equality Impact Assessment (EqIA), this can act as your action plan (see Section 3.1).

An action plan should be kept as a working document so that the facilities you offer to visitors can be measured and evaluated at regular intervals.

Table 3.5 Example of an action plan

Work area	Action
Visitor centre	
Improve access to facilities (toilets, seating etc), signage, visitor information, services (shop, café etc) and physical fabric, for all visitors.	Audit with building surveyor or manager and prepare an improvement plan. Arrange community feedback sessions with local groups and individuals.
Staff and volunteer awareness	
Ensure that staff and volunteers have the skills and experience to support all visitors. Create an ongoing system for existing staff to share these skills with new staff and volunteers.	Work with groups and organisations to run equality and diversity awareness training. Arrange training in sighted guiding to support visitors with sight loss. Review recruitment and employment policies.

Toilets	
Prioritise the provision of a separate all-gender accessible toilet.	Refer to building regulations and standards.
Car parks	
Ensure that car parks have clearly designated parking bays for disabled visitors, and drop-off facilities.	Renovate existing markings and signs so bays can be clearly seen. Add seating and shelters to drop-off point. Refer to building regulations and standards.
Routes and wider access	
Identify and promote routes that provide easiest access, and best quality visitor experience. Establish priorities for repair and improvement of existing routes.	Assign routes to zones (see Section A.2). Carry out an audit to establish which paths are currently accessible and what other physical barriers to access exist. Set priorities for improvements.
Play	
Improve access to play facilities.	Carry out access audits to evaluate all play structures, areas and surfaces. Ensure paths to and in play areas are as accessible as possible and that some play equipment has accessible features.
Providing information	
Improve accessibility of visitor information, including more information about site accessibility and alternative formats of information.	Develop online access information to share with a full range of visitors. Consult with local groups to identify priorities for information in different languages.
Improve site signage and wayfinding.	Undertake an audit of existing signs and wayfinding and identify priorities for improvement.

Interpretation	
<p>Ensure interpretation relates to different ages, abilities and cultural perspectives.</p> <p>Increase opportunities for multi-sensory engagement.</p>	<p>Involve a variety of local people in reviewing interpretation and informing priorities for development.</p> <p>Use this as an opportunity to invite stories and other material to feed the interpretation.</p>
Events	
<p>Review guided walk and event programmes to ensure activities cover different interests, abilities and cultural perspectives.</p>	<p>Review accessibility of facilities and timetabling.</p> <p>Work with local groups to create new walks and events to encourage people that wouldn't normally participate.</p>
Building relationships	
<p>Strengthen and widen links with individuals, groups and organisations.</p>	<p>Identify groups and schools that don't normally participate and organise community events to invite new audiences to engage with the site.</p>

A. Guidance

Paths and routes

.....

A.1 Planning paths and routes

Routes can provide access to and within a site or be destinations in their own right, such as local walks or countryside trails. Careful attention to their design and management is one of the most critical aspects of improving accessibility outdoors.

It is important also to balance technical aspects, such as gradients and surfaces, together with the quality of experience, keeping in mind the qualities that make a route feel welcoming, safe and attractive to use.

Routes vary enormously, both in their characteristics and in how they are used. In addition, they are managed differently in each of the four UK countries. This guidance aims to be as generic as possible, but the principles will need to be tailored to comply with the regulations and management practices in each country.

The need for improved routes

In many parts of the UK there is a shortage of paths and trails that people can confidently use. Routes are often poorly connected, inadequately signed and in need of repair. The issue is greater for people with access needs. At the same time, roads have become busier and less safe for walking, wheeling, cycling and horse riding. The contribution of new or improved routes is therefore very significant.

Route networks are especially valuable as they can provide a continued off-road experience. They can provide routes of varying lengths and character, and cater for a diversity of people and uses, including walking, wheeling and horse riding.

Ideally, they connect sufficiently for people to be able to join them from home rather than having to use their car. This can be especially significant for people in low-income households and those without access to transport. It can also relate to people with mental health problems, such as anxiety, who may rely more on their local environment for opportunities to go out and about.

Diversity of users

It is important to recognise the wide range of users, including walkers, wheelers and horse-riders. While some people are used to venturing outdoors, others have little experience and may lack confidence. It is widely acknowledged that representation matters; when people see other people that they identify with, they are more likely to feel comfortable and safe.

Some people enjoy exploring the outdoors as a solitary pursuit. However, for many people, the condition and ambience of the route can determine how safe they feel. This is an important consideration for path design and maintenance.

Remember that walkers will range from high-speed Nordic walkers to people who use a wheeled walking frame. The same applies to wheeled mobility equipment that ranges from large Trampler mobility scooters to basic wheelchairs intended for occasional use. There is an expanding range of wheelchairs, electric wheelchairs, adaptive bikes and scooters on the market that will make it possible for more people to access the outdoors. Larger scooters and all-terrain wheelchairs such as Mountain Trikes are opening up more challenging experiences across wilder countryside and mountainsides. Access guidance hasn't kept pace with the advances in design of wheelchairs and scooters for outdoor use. Many are bigger than manual wheelchairs and need more space.

Dog walking is an important outdoor activity for many people, including people with assistance dogs. However, some people have religious, cultural or personal reasons why they are not comfortable sharing a space with dogs. It is important to consider options for maintaining some dog-free areas (aside from assistance dogs) or where owners are required to keep their dogs on a lead.

Planning paths and routes for a diversity of uses will support a wide range of people and activities, for example:



istock.com/urbazon

Deaf people signing to each other



istock.com/SolStock

Families and friends wheeling together



Sensory Trust

People who need someone alongside



istock.com/Graham Oliver

Space to enjoy activities together



istock.com/Tashi Delek

Multi-users sharing a space



istock.com/russellbinns

Space to use a mobility scooter

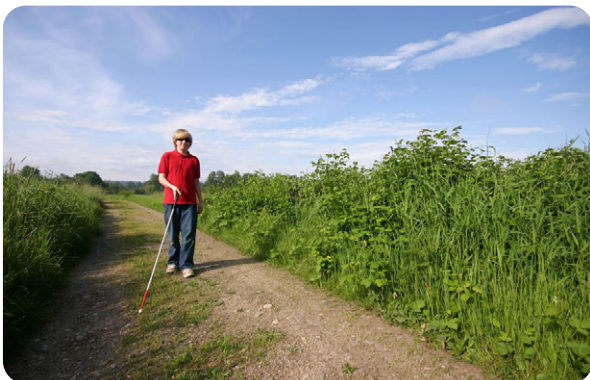

istock.com/RonBailey

Walkers using a long mobility cane



istock.com/Lisa5201

Families enjoying a space together

Planning new routes

New routes offer the best opportunity to minimise barriers to access and maximise usability. They should be planned with the involvement of people who will use them to ensure that their needs are met. The cooperation of landowners is also essential.

- Apply inclusive design principles to the planning, design and construction of routes and their associated features, such as seating and gates.
- Be as generous as possible with elements like path widths and turning spaces to future-proof these routes. For example, to allow for routes becoming busier and larger mobility scooters or adaptive bikes becoming more popular.
- Address how individual sections link with a wider route network so that overall accessibility can be considered. A route is only as accessible as its weakest point.
- Consider how a new path or section connects with access points from local communities, key facilities such as car parks, and the wider route network. The Access Chain is helpful for addressing these connections and developing a more comprehensive inclusive approach.
- Consider comfort, safety and sociability. For example, lighting, seating and good vantage points to make places feel safer; shelter and shade to add comfort; wider routes to support the social interactions of groups.
- Consider how routes may be affected by climate change and what can be done to make them more resilient and keep them accessible. Some surfaces may wear out more quickly and routes near rivers may become more prone to flooding. Longer growing seasons may increase the amount of maintenance that verges need to ensure that routes remain clear.

Improving existing routes

Maintenance and improvement works to existing routes should be seen as an important opportunity to improve accessibility. Recommended actions are:

- Review the accessibility of existing routes to identify priorities for improvements.
- Invite communities to highlight issues that are limiting the use of existing routes and to find potential ways of resolving them. Harnessing community involvement is important for encouraging greater use which in turn will help make routes feel safer and more welcoming to a wider diversity of users.
- Apply the least restrictive approach to any improvements to sections of a route. This will mean that over time the accessibility of the whole route can be enhanced. This should include any associated features such as gates.
- Prioritise improvements to sections of routes that connect with key features and facilities.
- Prioritise the avoidance of dead-ends and places where wheelchair users

and mobility scooters need to turn around and retrace their route. If this is not possible, add sufficient turning space (see [A.4 Reach](#)).

Safe and welcoming routes

It is widely reported that concerns about personal safety and antisocial behaviour are higher for disabled people, women, minority ethnic people and people who identify as LGBTQ. Some characteristics, such as dark, dense woods and remote locations, can heighten concerns about personal safety.

It is important to address these aspects when planning new routes or improving existing ones, for example by considering the following:

- Working with community groups and individuals to understand the issues and to identify potential measures that can help.
- Encouraging more use by a wider diversity of people. For example, when women see other women using a space, they are more likely to feel safer.
- Aim for a more open landscape with good sightlines, avoiding blind corners and dark, oppressive areas.
- Good maintenance. It is well documented that places that show signs of neglect or damage generally feel less safe and welcoming.
- Lighting, particularly to give reassurance for early morning and evening use.

Shared routes

In this guide the term shared route refers to ones that are open to a mixture of non-motorised uses such as walking, cycling, horse riding, wheelchair and mobility scooter use. These are also often referred to as multi-user routes, greenways and trails.

In Scotland, most routes are 'shared use' while in the rest of the UK they form part of a more complex system of public rights of way. The detail of how they are defined and planned is beyond the scope of this guide but there are signposts to more information below.

When designed to be safe and appealing for all users, multi-user routes provide popular, flexible spaces that people can enjoy for recreation, health benefits and getting to and from work and school. Their development has become increasingly important as the availability of traffic-free routes has declined and roads have become busier and more unsafe for pedestrians, horse riders and cyclists.

Shared space versus separated space

Some multi-user routes provide openly shared space and others contain defined lanes for different users, most typically separating bicycles from pedestrians. There are pros and cons for both:

- Shared space offers the greatest flexibility, for example with more room for groups to walk or wheel alongside each other. However, the undefined mix of uses can feel uncomfortable and potentially hazardous for some

walkers, particularly people who are blind and partially sighted or D/deaf and hard of hearing.

- Defined spaces enable cyclists and horse riders more freedom to move at their desired speed and they give greater reassurance to walkers and wheelchair users. However, there can be conflict from territorial behaviour and cyclists and pedestrians moving into each other's space.

It is important to plan according to the specific situation and in particular the level of use. Generally, defined spaces are recommended for busier routes. It is recommended that shared routes should only be considered if pedestrian flows are less than 100 people per hour per metre of width.

A fully shared surface may be a better option if the alternative is to divide a route into sub-optimal widths for cyclists and other users. This is likely to be the situation if a total route width is less than 3m.

Key considerations:

- Consulting with groups that reflect the full diversity of uses and users is critical. People with protected characteristics are often missed from conventional consultation techniques and inclusive approaches are key (see Section 3.3).
- Adequate route widths and gathering spaces are essential for the effective functioning of shared routes. Generally, the wider the route the less conflict there is likely to be between users (see Section A.4).
- Seating, shade and shelter will add to the social value and appeal of shared routes and widen the range of people who will feel comfortable using them (See Section B.1).
- Clear signage is essential to show legitimate uses and codes of conduct.
- Regular maintenance and an efficient response to user concerns will contribute to how safe and confident people feel using a route.
- All potential uses and users must be considered, in particular people with limited mobility, people who are D/deaf and hard of hearing and people who are blind and partially sighted who can find shared use more challenging. Provision for cycling must consider adaptive bikes, including larger ones such as trikes and cargo bikes, as well as people who want to cycle slowly or who need to have someone cycling alongside (See Section A.12).
- Use of painted lines to demarcate different uses is not recommended as these are hard to detect by people who are blind and partially sighted, and easy to overlook by people generally. The 'Cycle Infrastructure Design' guide below provides more information on appropriate methods.

For recommended widths of multi-user routes see Section A.3.



Examples of good practice



istock.com/SolStock

Paths and routes that serve housing areas allow more people to access outdoor spaces and benefit from outdoors spaces without relying on transport.



istock.com/M-image

A choice of different routes is beneficial as long as people know where they go and how accessible they are. Signage and information are key.



Forestry England

A masterplan created by Julia Matthews for Forestry England’s recreational site at Haldon Forest. It highlights route zoning and access priorities.



Further guidance on route planning

Paths for All and NatureScot, Outdoor Access Design Guide www.pathsforall.org.uk/resource/outdoor-access-design-guide

Sustrans Traffic free routes and greenways design guide. 6. Space requirements www.sustrans.org.uk/for-professionals/infrastructure/sustrans-traffic-free-routes-and-greenways-design-guide/sustrans-traffic-free-routes-and-greenways-design-guide-contents/2019-design-guidance/part-2-design-details/6-space-requirements/

Disability Sports Northern Ireland, Accessible outdoor places guide. 1.2.3 External route width and 1.2.4 Clear headroom www.dsni.co.uk/wp-content/uploads/2021/07/Guide-5-Accessible-Outdoor-Places-Design-Guidelines.pdf



Further guidance on multi-user routes

Cycle Infrastructure Design, Department of Transport, Local Transport Note 1/20, 2020 www.gov.uk/government/publications/cycle-infrastructure-design-ltn-120

Creating Multi-user Public Rights of Way: A Guide for Local Groups by Rachel Thompson for the Trails Trust www.thetrailstrust.org.uk, supported by Natural England and defra 2011

Sustrans traffic free routes and greenways design guide: 4 sharing of paths www.sustrans.org.uk/for-professionals/infrastructure/sustrans-traffic-free-routes-and-greenways-design-guide/sustrans-traffic-free-routes-and-greenways-design-guide-contents/2019-design-guidance/part-1-general-principles/4-sharing-of-paths/

Shared use paths in Scotland, Paths for All www.pathsforall.org.uk/mediaLibrary/other/english/shared-use-paths-in-scotland.pdf

A.2 Path and route standards, grades and audits

Access standards

These access standards are based on the most widely agreed technical standards and reflect the technical guidance in Section A paths and routes. They are broadly consistent with wider standards that have formed the basis of this updated guide. They also align with the [By All Reasonable Means](#) (BARM) guides which are framed by the same approach, combining Least Restrictive Access and [Access Chain](#).

The original 'Countryside for All' guide was one of the most significant efforts to create a national system of standards for physical access in the countryside. These were updated in the BARM guides to reflect a wider range of settings, including less managed areas.

The standards relate principally to physical barriers to access on routes and their impact on disabled people. Even within the wider remit of the Equality Act, this continues to be an effective way of addressing the accessibility of routes and sites. However, it is essential to also consider the wider social and psychological barriers that are highlighted in the site review that is based on the Access Chain (see Section D.1).

It should be noted that statutory regulations and standards should be used where they apply.

Applying access standards

The choice of access standards will depend on the nature of the space, its intended role and any statutory limits such as nature conservation status. Standards should be seen as minimum recommendations and the aim should be to exceed them where possible. This follows the principle of Least Restrictive Access. For example, a wilder, lightly managed site or route that may have to apply lower standards for aspects like gradients and surfaces, may still be able to achieve higher standards for specific elements such as gates.

Access standards should also respond to patterns of access. The development of mobility vehicles with longer battery life and greater stability is enabling some disabled people to explore longer distances and more challenging terrain, as long as there are no barriers such as narrow gateways, steps or stiles.

Prioritising routes for audit

Paths with the following characteristics would typically be a high priority for review and assessed against the highest standards:

- Paths that lead to or are part of a longer accessible route.
- Paths that lead to popular walks and destinations, eg to a village hall, shop or community centre.

- Paths that local people already use or would like to use.
- Paths in recreation sites such as country or urban parks, where there are existing or anticipated, accessible toilets, refreshments and formal car parking facilities.
- Paths in sites that are particularly significant to local people, such as community woodlands and cemeteries.
- Paths that can be reached by accessible public transport, or where there is potential to develop accessible public transport.
- Paths that give access to designated historic sites, habitats, high quality scenery or other features of interest.

Paths with the following characteristics would typically be assigned to lower priority and assessed accordingly:

- Paths where there are no nearby accessible facilities, or where it is inappropriate and economically unviable to provide such facilities.
- Isolated paths where few people are likely to use the route (those in areas of significant heritage value may be an exception to this rule).
- Paths where accessible public transport or parking places are unlikely to be provided.
- Paths where options for improvement are constrained by natural site characteristics such as difficult topography.
- Paths in locations with high landscape value, where the visual impact of a fully accessible path cannot be disguised or is undesirable.
- Paths where the cost of improving and maintaining to the highest access standards cannot be justified.

Lower priority should not be seen as a reason to apply low standards in remedial works. As emphasised in BS 5709:2018, any new works should aspire to the highest standards and this will increase the accessibility of all routes over time. The principle of Least Restrictive Access is crucial here, as an improvement such as replacing an inaccessible gate with an accessible gate can open up access to more people.

Management zones

The standards in this guide relate to three Management Zones – A, B and C – and have been developed to help you review existing accessibility and plan improvements. It is important to remember that full access for all disabled, and non-disabled, visitors relies on all links in the [Access Chain](#), such as information and transport, as outlined earlier in this guidance.

With all zones, it is essential to apply the principle of Least Restrictive Access and to seek the highest level of improvement possible.

Zone A	Formal, intensively managed landscapes (eg visitor centres, urban landscapes, recreational hubs)	Applies the highest access standards and provides access for the most people.
Zone B	Informal, moderately managed landscapes (eg walking and cycle trails, country parks, urban fringe)	Access standards are lower but Least Restrictive Access approach maximises opportunities.
Zone C	Open, wilder, lightly managed landscape without major barriers (eg open countryside, nature reserve, woodland)	Access standards are lower but Least Restrictive Access approach maximises opportunities.
Some areas of wild, open countryside and forest will be outside the zoning system, but if improvements are planned, they should aim to meet at least Zone C standards.		

Table A.2a Path and route management zone standards

	A	B	C
Barriers ¹	No stiles, steps or physical barriers restricting access. No gates narrower than 1100mm (1500mm in Scotland).	No stiles, steps or physical barriers restricting access. No gates narrower than 1100mm (1500mm in Scotland).	No stiles, steps or physical barriers restricting access. No gates narrower than 1100mm (1500mm in Scotland).
Surface ²	Firm and even in all weathers, clear of loose stones and debris.	Firm, with a few loose stones and debris.	Path not firm in all weathers, loose materials, occasional tree roots, potholes and stretches of rutting.
Width ³	Meets recommended widths in Section A.3. No passing places needed.	At least 1200mm wide with passing places at least every 50m.	At least 1000mm with passing places at least every 150m.

Width restrictions ⁴	Narrower sections are limited to 1200mm wide.	Narrower sections are limited to 900mm wide.	Narrower sections are limited to 850mm wide.
Resting points ⁵	At least every 100m.	At least every 300m.	Not formalised. Resting points make the most of existing features.
Gradient ⁵	Maximum 1:20 (5%) with level areas for gradients over 1:60 (1.7%).	Maximum 1:12 (8%) and any gradients steeper than 1:20 (5%) detailed as ramps.	Maximum 1:10 (10%) over very short distances (600mm).
Crossfall or camber ⁶	1:50	1:50	1:35
Surface breaks ⁷	Maximum 5mm gap measured across the line of the path.	Maximum 5mm gap measured across the line of the path.	Maximum 12mm gap measured across the line of the path.
Height clearance ⁸	Meets recommended heights in Section A.3.	Meets recommended heights in Section A.3.	Does not meet recommended heights in Section A.3 but there are no solid structures limiting headroom.
Distance ⁹	Route includes shorter loops or easy return options.	Route includes shorter loops or easy return options.	Route is lengthy with no shorter loops or easy return options.
Clarity ¹⁰	Route is clearly defined by its surface.	Route is clearly defined.	Route may be undefined, but it is still clear enough to follow.

1 Barriers: Barriers such as stiles, steps, narrow widths, rough surfaces and large stones and roots can cause significant restrictions for many people, especially disabled people, people with low stamina, older people, cyclists and horse riders. These will prevent a path from reaching any of the standards and will always be a priority for improvement, either to remove or avoid.

2 Surface: A category A route surface will be non-slip, well-drained and even. Access is limited by loose material and debris on the surface, trip hazards such as tree roots, potholes and other irregularities in the surface. The categories reflect the extent to which the surface quality is likely to impact accessibility.

3 Width: Width impacts who can use a route, whether they can walk or wheel

together and how easily people can pass each other. Widths here refer to the usable section (which is often the hard-surfaced section) which can be reduced by encroaching vegetation or side erosion of the surface. Passing places ensure that people have room to pass each other on widths that don't meet category A dimensions.

4 Width restrictions: Some restrictions are created by permanent features such as gates, trees and walls. These may be a reason for seeking alternative routes or plans.

5 Resting points: Seats and perches are important to all visitors and essential for people who cannot walk long distances without resting. Wheelchair users also need places where they can stop and rest. Landings are the level areas that provide resting points along a sustained gradient. The frequency of resting points is not intended to be exact but used as a general guide.

6 Gradient: Gradients impact many visitors, especially people with mobility disabilities and people who tire easily. Downslopes can sometimes be more hazardous for people than upslopes, especially if there is loose material on the surface.

6 Crossfall: Crossfalls are challenging for people with mobility disabilities. They can reduce the usable area of a path to the central strip and significant crossfalls can be hazardous if they lead to areas of open water or steep-sided drops along the side of a path.

7 Surface breaks: Gaps in the path surface from drainage channels and other structures can present a complete barrier to wheelchair users and can trap walking aids.

8 Height clearance: Overhanging vegetation can be uncomfortable, or hazardous, for blind and partially sighted people. A priority should be to remove any thorny or spiny vegetation at eye level. Horse riders will need 3.7m height of clear passage.

9 Distance: The length of a route can have a significant impact on people with limited stamina, especially when combined with gradient and lack of resting points. Introducing shorter loops and easy options for people to return the same way are important elements of improving accessibility.

10 Clarity: This relates to how clear the route is so that people can follow it easily. This is helped by edging, which can also be an important navigation aid for blind and partially sighted people.

Route audits

It is preferable to audit all selected paths and routes against the highest possible standards, in line with a Least Restrictive Access approach, as this provides a complete dataset of their condition. This will help identify routes assigned to one setting or zone that are better than the associated standards and those that fall short.

Where resources for auditing are more limited, paths can be audited against the standards of the particular setting or zone applied to them. This may

be quicker and therefore less costly than auditing paths against the highest standards. The amount of recording is reduced as the audit only records where a path does not meet the standard, by how much and where this occurs. For example, for a Zone B path, an auditor will only need to record where the path is narrower than 900mm rather than 1000mm and so on.

The disadvantage of this approach is that the audit will not establish where the path is better than the standard, and by how much. It is therefore important that auditors also make general notes if the path appears to be considerably better than the standards of the zone assigned to it. Once the audit is complete, the path may be reassigned to a setting or zone with higher standards and may require a further audit against these new standards.

Auditing is not easy; it is time-consuming and there is a lot to think about and many decisions to make, such as where a path surface changes sufficiently to need to record a change.

Given the significance of the quality of the data, it is essential that well trained people carry out the audit. They must be fully aware of why the audit is being undertaken, of the standards they are auditing against, and the importance of ensuring consistency by auditing in the same way, every time. There is an element of subjectivity with auditing, such as deciding where the stones on a path change from 'occasional' to 'some'. To obtain data that is as consistent as possible, it is recommended that this task be undertaken by the same members of staff in consultation with a representative group of disabled people who concentrate on auditing over a period of time.

It is helpful to develop a template to record the information from a route audit as this will help ensure there is consistency in how the information is gathered.

Time of year to audit

There are advantages and disadvantages to auditing either during winter or summer. Winter can be useful for highlighting issues such as muddy sections and standing water on paths, while summer can identify areas where access becomes more limited because of encroaching vegetation. However, it is appreciated that where a large number of paths need auditing, restricting this activity to either time of year may be difficult.

If audits are undertaken at a time of year when paths are not in their worst condition, it is important that this is taken into account when analysing the data and when providing information based on this data.

Grading paths and routes

The wide variety of routes, from intensively managed urban paths to trails through open countryside, makes it unrealistic to apply a one-size-fits-all approach. It can be helpful therefore to use a system that identifies different categories of route.

Categorising routes is a simple way of sharing information about them. Reducing information in such an abbreviated way does have obvious

limitations, but it can be helpful in giving an indication of the nature of different routes.

The problem with simply adopting conventional grading systems is that they don't always take into account access needs. For example, a description of an 'easy' grade might still encompass features such as steps that could make a route unusable for some people.

When considering new or modified grading systems it is important to consider the following:

- See what systems are already used in your area and align if possible. Of course, this may not be appropriate if the system isn't inclusive, or if it is aimed at a particular user group such as cyclists or horse riders.
- Grade according to the nature of the path, not by people's abilities.
- Be consistent so the grades always mean the same thing.

The information obtained from site and route reviews can be used to inform a grading system. Routes are allocated a particular rating which gives people a general idea of how challenging they are. See Section A.2.

The details can also be shared in access guides, which are an opportunity to give people more idea of what a visit entails. See Section C.1.



Further guidance

Disabled Ramblers disabledramblers.co.uk/route-categories/

Experience Community www.experiencecommunity.co.uk/

The path manager's guide to grading: standard waymarked path grading system for Scotland, Paths for All. www.pathsforall.org.uk/resource/the-path-managers-guide-to-grading

A.3 Path dimensions

The width of paths or routes is a major factor in determining who can safely and comfortably use them. It has a significant influence on how people can enjoy an outdoor space; whether they can walk or wheel together, pass each other easily, move into a seating space or negotiate a turn, and pause without blocking the way.

It is essential to recognise the advances in the capability and size of wheelchairs and scooters for outdoor use. All-terrain models have increased in capability and can safely negotiate more challenging landscapes. The larger models may not be able to use paths that were designed to the dimensions of manual wheelchairs and small scooters.

Smaller class 2 scooters are not allowed on the public highway and are mostly used indoors. Class 3 scooters can be used on public highways and open up more opportunities to access the outdoors. The Trampler is an example of one of the larger class 3 scooters that is increasingly used to access the countryside. The Research Institute for Disabled Consumers (RiDC) provides information about the different types of scooter: www.ridc.org.uk/features-reviews/out-and-about/choosing-wheelchair/mobility-scooters/class-2-and-class-3-mobility#:~:text=Class%20%20mobility%20scooters%20can,small%2C%20lightweight%20and%20compact

We recommend:

- Upgrading existing infrastructure to support the use of new mobility equipment so that more people can enjoy these routes. This can also reduce the risk of all-terrain equipment making their own alternative routes over ground that may compact it or damage the vegetation.
- Adopting more generous widths and spaces, where possible and appropriate, as a way of future-proofing.



What does inclusive practice look like?

- ▶ Usable widths support safe and comfortable use. Widenings and passing places are added where ideal widths cannot be reached along a whole length.
- ▶ Path widths enable people to enjoy the experience of moving through the landscape together and at their own pace.
- ▶ Shared-use routes provide safe use for all users.
- ▶ Regular reviews identify how well paths, trails and other routes are meeting diverse demands.
- ▶ Regular maintenance keeps usable widths of routes clear of obstacles and encroaching vegetation.

Key considerations

Users: Walkers, wheelchair and mobility scooter users, pushchairs, cyclists, horse riders, or a combination of some or all of these. The more users, the wider the paths need to be.

User needs: Some people need to be side by side with a companion, assistance dog or young child and some use a double pushchair. Group activities, such as a health walk, rely on the social interaction that people gain from walking or wheeling together. Wider routes support more users and greater social interaction.

Volume of use: The busier the route, the more likelihood of conflict between different users and uses. Greater widths and delineation between uses will help.

Physical challenge: Paths with more challenging surfaces and gradients will need more frequent resting points.

Surface width isn't always usable width: Over time the usable width often reduces because of encroaching vegetation and surface erosion at the sides.



Design guidance

Path width requirements

The following illustrations show width requirements for a diversity of needs. The dimensions are in millimetres and reflect the space envelope rather than the exact widths of different users.

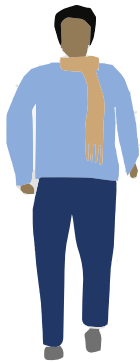

700mm
single person



750mm
adult with
walking stick

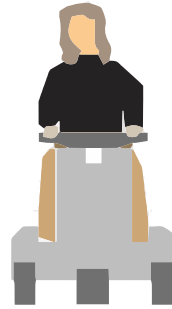

850mm
scooter user



900mm
wheelchair
user

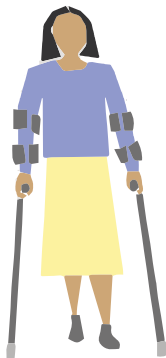

900mm
double stick,
crutches
or walking frame

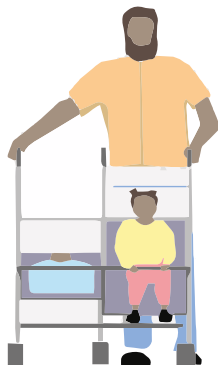

1000mm
double
pushchair

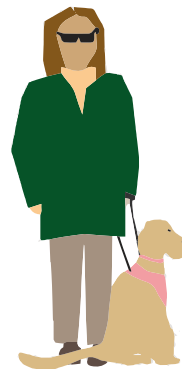

1100mm
adult with
assistance dog



1100mm
long cane
user



1100mm
adult and child



1200mm
adult and helper



1200mm
deaf people
signing

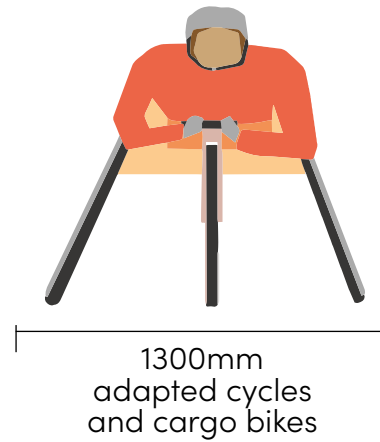
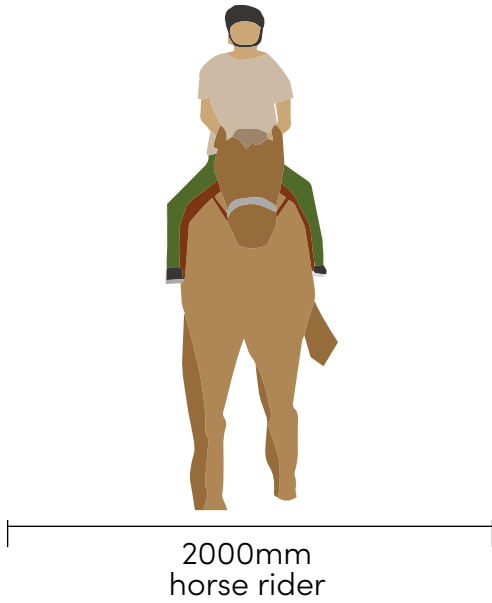
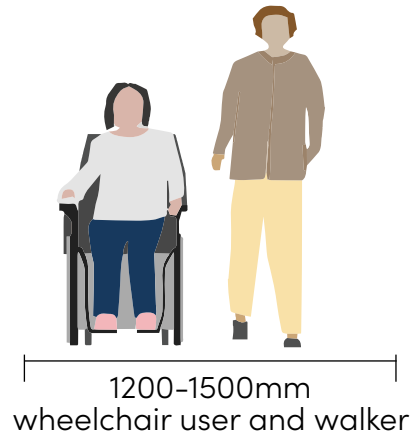
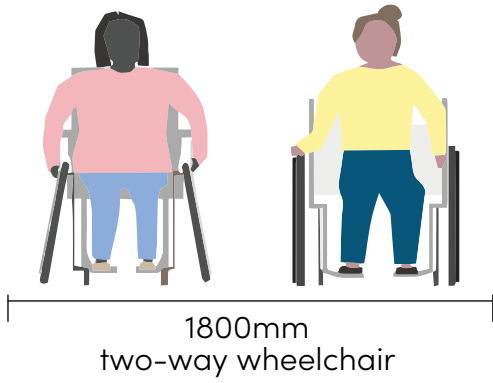

Width requirements for different path users.

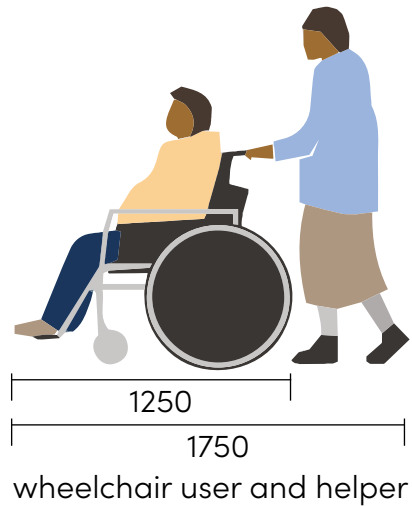
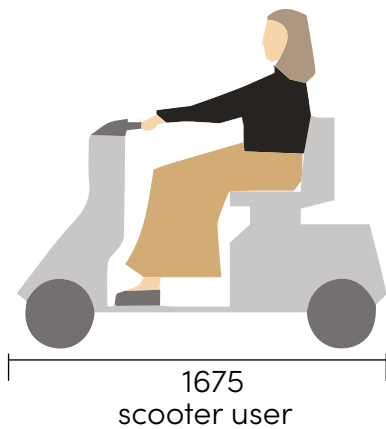

Typical length ranges for wheelchairs and mobility scooters.

Path width recommendations

Path widths should reflect the type of route, how busy it is and the experiences on offer.

The following dimensions relate to the usable width of a path, excluding encroaching vegetation and loose or sloping edges.

Where possible, paths should be sufficiently wide for people to walk or wheel side by side and for people to pass each other. Wider paths can achieve this without the need for passing places. As the diagrams above and below show, any route less than 1200mm wide will limit use by some people.

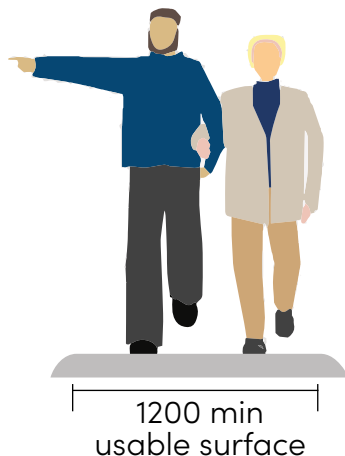

Two-way with no passing places:

- 1800mm allows for two-way movement including people using wheelchairs, small-medium mobility scooters and double pushchairs.
- 2000mm allows more comfortable space for people to walk or wheel side by side and for people to pass each other.
- 3-5m for multi-user routes, depending on the volume of use and range of uses. Greater width reduces potential conflict between users and is key to making routes safe and convenient for everyone.

Two-way with passing places:

- 1200mm (preferred 1500mm) requires passing places every 50m to enable wheelchair users and mobility scooters to pass.

Passing and pausing

- Regular opportunities to stop and rest are essential for many older and disabled people, and important for most. Seating is an essential access ingredient and should be allowed for as part of considering path widths.

- Passing places should be at least 1800mm wide and 2000mm long, ideally 2000mm x 2000mm. This will allow enough space for two wheelchair users to pass each other.

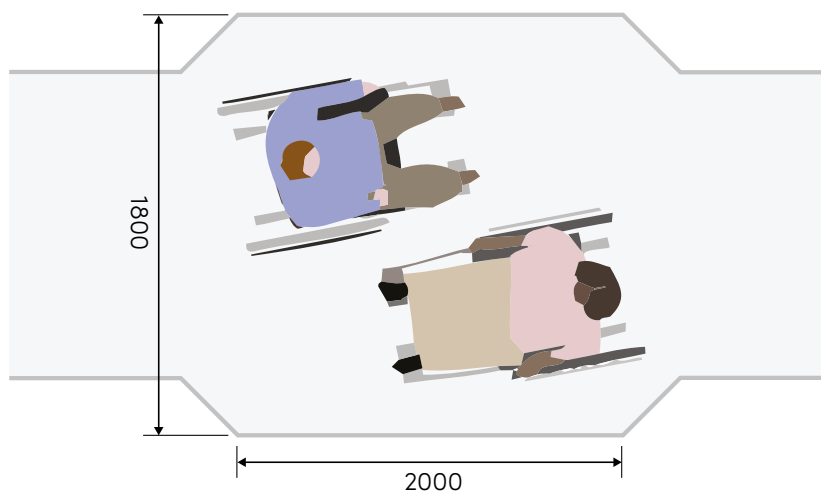

Manoeuvring and turning space

Sufficient space is required for people using wheelchairs or mobility scooters, cycling or horse riding to manoeuvre safely and easily. This includes path turns, negotiating features such as gates and moving into a space such as a sitting area.

More details on manoeuvring space are provided in Section A.10 Gates, gaps and stiles and B.10 Birdwatching.

Space to turn through 90 degrees:

Manual wheelchair: 1500mm x 1500mm

Electric wheelchair: 1600mm x 1600mm

Attendant-pushed wheelchair: 1800mm x 1800mm

Mobility scooter: 1400–2500mm x 1300–2500mm

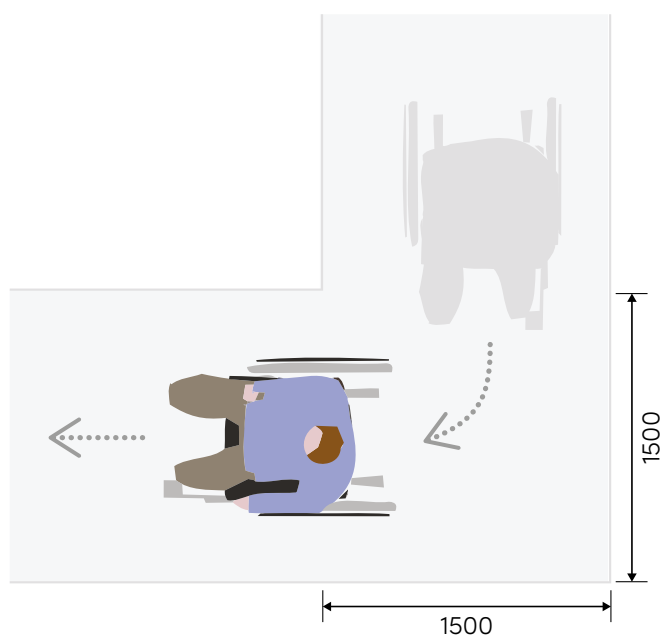

Space to make a U-turn:

Manual wheelchair: minimum 2000mm x 2000mm

Electric wheelchair and small mobility scooter: 2300mm x 1600mm

Attendant-pushed wheelchair: 2000mm x 1800mm

Mobility scooter: 2000–2800mm x 1300–2200mm

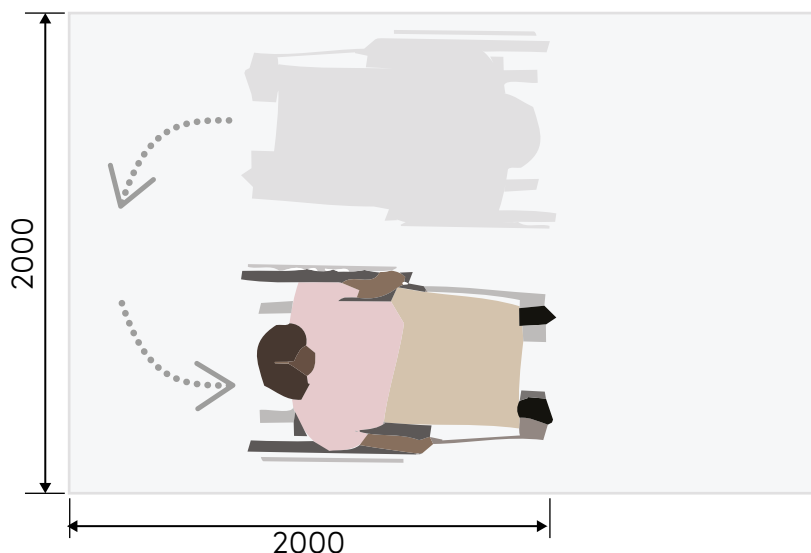

Adaptive bikes: see Section A.13

Horse riders and horse-drawn carriages: see Section A.14

These dimensions are based on information in BS8300-2:2018 Annex G: Space allowances for wheelchair manoeuvring.

Note that some larger mobility scooters require more space. For example, a Trampler scooter requires 4.2m width to make a 180 or 360 degree U-turn in one move. Being as generous as possible with turning space will allow for wider use and help futureproof sites and routes.

Head height clearances

Objects that overhang a path can create hazards for anyone and particularly for blind and partially sighted people. Adequate clearance at and above head height should take into account people walking, cycling, horse riding and using wheelchairs, mobility scooters and pushchairs.

- Clearance above head height should be at least 2400mm to allow for people walking, using a wheelchair or mobility scooter, and cycling. Pay particular attention to the height of vegetation and signs.
- Extend this clearance to 3.7m, to allow for horse riders. Where possible this is the preferred minimum for all users. Allow a minimum clearance of 500mm each side.
- Clear space should be maintained across the width of a path.

Maintenance

- Removal of encroaching vegetation and obstacles on paths is essential to maintain a usable width.
- Repairing surfaces to match or exceed existing quality is essential. Adding loose materials as a quick fix is a widespread approach that is reducing accessibility of many routes throughout the UK.



Examples of good practice

Scotland's National Path Demonstration Site, Paths for All

This site in Scotland's Rural College (SRUC) Oatridge Campus, West Lothian demonstrates good practice in path construction and design. It helps anyone involved in path design and access improvements. If you are too far away to visit, there is a video and other materials on the Paths for All website: www.pathsforall.org.uk/community-paths/cmp-the-national-demonstration-site



Paths for All

Wider path widths enable people to walk together and enjoy the social experience as a group. Paths for All dementia friendly woodland.



Able2Adventure

Path widths need to take account of the expanding range of mobility equipment.



Large mobility scooters, such as Trampers, need more space to turn and manoeuvre. This viewing shelter at Haldon Forest, Devon, provides clear space to enable people to move around and offers well positioned viewing heights.



Further guidance

Paths for All and NatureScot, Outdoor Access Design Guide www.pathsforall.org.uk/resource/outdoor-access-design-guide

Sustrans Traffic free routes and greenways design guide. 6. Space requirements www.sustrans.org.uk/for-professionals/infrastructure/sustrans-traffic-free-routes-and-greenways-design-guide/sustrans-traffic-free-routes-and-greenways-design-guide-contents/2019-design-guidance/part-2-design-details/6-space-requirements/

Disability Sports Northern Ireland, Accessible outdoor places guide. 1.2.3 External route width and 1.2.4 Clear headroom www.dsni.co.uk/wp-content/uploads/2021/07/Guide-5-Accessible-Outdoor-Places-Design-Guidelines.pdf

A.4 Reach

Reach relates to how easily people can physically interact with something, from reaching their coffee on a picnic table to operating a car park ticket machine.

Not being able to reach something impacts most people some of the time, and some people most of the time. People of short stature, for example, have to ask for assistance when the parking machine is too high to self-serve their ticket, and a blind wheelchair user will not be able to access the braille on an interpretation board if it is not positioned at an accessible height and angle. It is also recognised that women often have to adapt to design that is based on male anthropometrics. Even in female toilet facilities it is not uncommon to find fittings like mirrors and coat hooks positioned too high for the majority of women to use comfortably.



What does inclusive practice look like?

- ▶ Tactile interpretation and information materials can be accessed by people of different heights, including wheelchair users.
- ▶ Catches and latches on gates and door handles are designed to be easy to reach and use and have good colour contrast.
- ▶ Tables, counters, machines, phones etc. are at an accessible height.
- ▶ Electronic crossing controls are within reach (including horse riders, as appropriate).
- ▶ Play opportunities have considered reach dimensions for young wheelchair users.



Design guidance

Clear access

- Ensure that any features and devices intended to be reached have clear access to and around them, including any turning space required for wheelchairs and scooters.
- Provide adequate clear space so that people are not blocking the way when they stop to explore something, whether an interesting tree bark or some tactile interpretation.

Flexibility

- Keep in mind that some people will have use of one arm only, so avoid designs that require both arms to be reached out at the same time.
- Aim for designs that accommodate as wide a range of reach as possible. For example, a vertical tactile panel offers people's hands a wider range of heights than a horizontal one. Varying the height of tactile interest along a sensory trail helps ensure that there are opportunities for children as well as adults.

Open reach

- In general, handles, levers, buttons, card machines etc. should be placed at a height between 900-1200mm above ground level. Some wheelchair users may be able to reach outside this range, but it is likely to involve leaning which is uncomfortable or impossible for others.
- Ensure that handles and devices that require hand movement are easy to use, allowing for limited dexterity of someone with arthritic hands for example.
- Forward reach (measured at chest height) should be limited to a distance of 500mm, with 600mm as a maximum.
- It is important to refer to the standards identified in the British Standards and regulations.

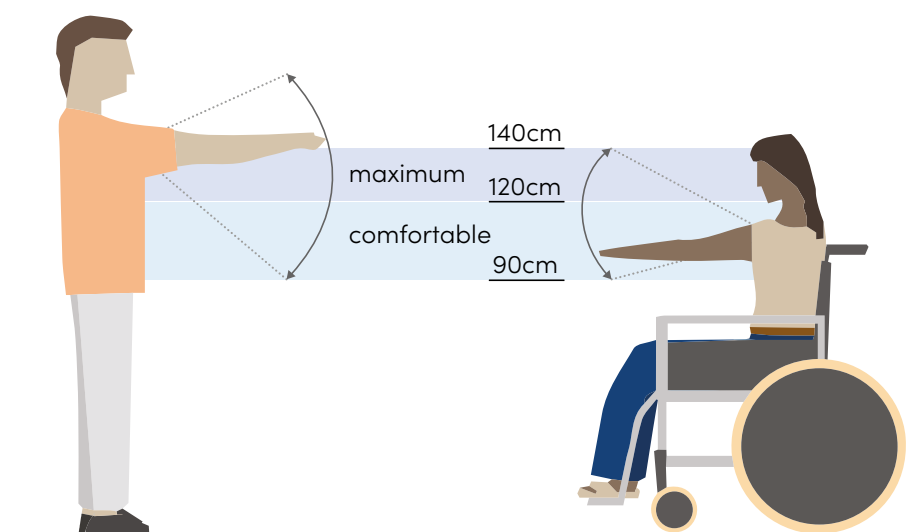

Tabletop reach for wheelchair users

- Forward reach: The ideal height for a tabletop is one that enables wheelchair armrests to slide underneath. Items to be handled should be no further back than 500mm (600mm maximum) from the table front.
- Side reach: Maximum 600mm to reach sideways.

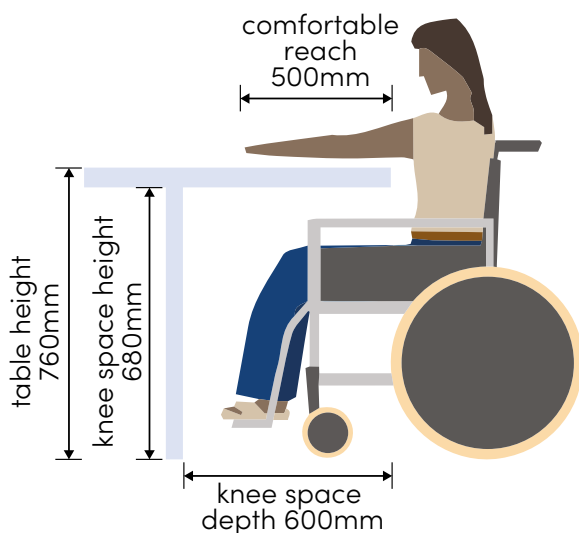



Further guidance

BS 8300-1:2018: Annex E: Reach ranges

www.shop.bsigroup.com/products/design-of-an-accessible-and-inclusive-built-environment-external-environment-code-of-practice/standard

Inclusive mobility: A guide to best practice on access to pedestrians and transport infrastructure Department for Transport, 2021 www.gov.uk/government/publications/inclusive-mobility-making-transport-accessible-for-passengers-and-pedestrians

A.5 Views and viewing heights

This section relates to how easily people can enjoy access to a view as well as information on maps and signs. This is particularly important for wheelchair users and people of short stature who can find their views blocked by objects such as information boards that have been placed at their eye level, or railings that only facilitate views over the top.

Viewing points are designated places where people can enjoy an open view across the landscape, or a more specific feature, such as the view of water from a bridge. The same principles of maximising the accessibility of these views apply.



What does inclusive practice look like?

- ▶ The viewing point is clearly signed and easy to access from the car park, or places where people will be travelling from (eg a visitor centre).
- ▶ A choice of viewing points provides greater flexibility in terms of distance and experiences on offer.
- ▶ Non-visual ways of interpreting views are available such as tactile illustration or audio-visual displays for people who don't have sight as their primary sense.
- ▶ Rails and railings are designed to maximise views at different heights.
- ▶ Signage, interpretation and information are placed at convenient viewing heights.



Design guidance

Viewing points

- Ensure the route to a viewing point is accessible and well-marked. The surface of the viewing point should be firm, level and stable with sufficient turning space for wheelchairs, adaptive bikes and scooters.
- Provide seating and shelter at viewing points, including space for mobility scooters, buggies and wheelchairs.
- Ensure that any information or interpretation materials take account of different viewing heights, including wheelchair users and people of short stature, and do not obscure their view.
- Ensure that vegetation is managed to maintain views.
- If telescopes are provided, ensure that they have a variable height control and knee space between the telescope and the ground to provide wheelchair and scooter access.

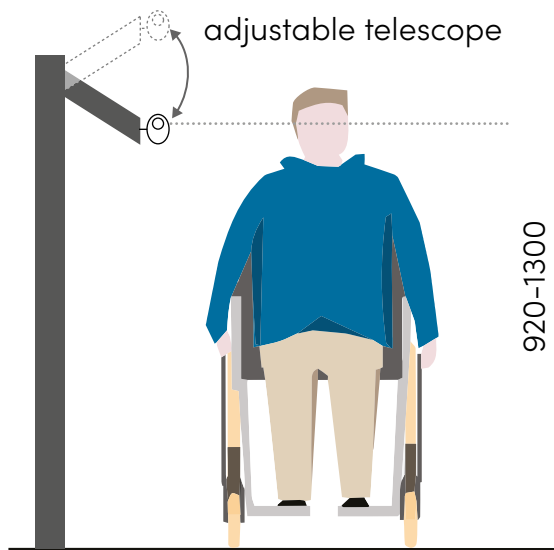

ensure there is enough knee space under the telescope for wheelchair users

- If there is a structure, provide a shelf for people to lean against when using cameras or binoculars.

Guardrails

- Building regulations identify a minimum height of 1100mm for a guardrail, with additional rails below. Depending on someone's proximity to the rail and the relative position of what is being viewed, this can put the top rail and other rails at the eye level of a wheelchair user. This can also impact someone of short stature and children.
- Providing gaps or holes, or clear vision panels, lower down can provide viewing opportunities for people of different heights.

Signs and information

- Ensure clear access to signs where people need to touch tactile information or read.
- Position signs within the cone of vision so that they can be read by ambulant people of different heights as well as wheelchair users:
1m viewing distance: position between 800mm and 1850mm high.
2m viewing distance: position between 700mm and 2150mm high.
3m viewing distance: position between 650mm and 2400mm high.



Examples of good practice



Forestry England

At Forestry England's Haldon Forest site, the viewpoint is designed so that everyone can enjoy the view including pre-school children and wheelchair and Trampler users, while still blending with the woodland setting.



Forestry England



Further guidance

BS 6180:2011 and Approved Document K www.gov.uk/government/publications/protection-from-falling-collision-and-impact-approved-document-k

Scottish Government, Building Standards technical handbook 2017: 4.3 Stairs and ramps www.gov.scot/publications/building-standards-technical-handbook-2020-domestic/4-safety/4-3-stairs-ramps/

Paths for All Signage Guidance www.pathsforall.org.uk/resources/resource/signage-guidance-for-outdoor-access

A.6 Path surfaces

The quality of surface has a major bearing on the accessibility of a path or route. A loose or uneven surface, even on level ground, will reduce its usability by people with mobility issues and may be very difficult for wheelchairs and pushchairs. Loose materials on a slope can be a hazard for everyone.

Surfaces are often a detail that can be more easily changed, and it is important to consider carefully which materials will provide the best result. The aim should be for a surface that is in keeping with its setting whilst providing a firm, even, slip resistant surface in all weathers.

Quality of construction is a key issue and the better the construction, the better the path and the longer it will remain in a good state. Skilled maintenance and prompt repair are critical as even the best laid paths can develop issues over time. Poor maintenance practices can create new accessibility issues, for example by topping a previously fine-surfaced route with a coarser aggregate.



What does inclusive practice look like?

- ▶ Paths and routes are safe and comfortable to use by all users.
- ▶ Consistent and predictable use of tactile surfaces (eg corduroy hazard warning surface) provides warnings for people who are blind and partially sighted.
- ▶ The accessibility of the path surfaces at the starting point(s) of a route reflects what people are going to find as they venture further along. This means that people can be confident their journey will be manageable and without unexpected challenges.
- ▶ Regular maintenance keeps surfaces in good repair and true to the original specification.



Design guidance

Materials

- Surfaces should be firm, even and slip-resistant in dry and wet weather conditions and compact enough to withstand impact from feet, wheels and horse hooves.
- Loose materials such as gravel should be avoided as a path surface. These are not stable, they move unpredictably underfoot and wheels can get stuck. They are difficult for wheelchairs and pushchairs and many ambulant disabled people. Loose materials spilling onto hard surfaces can make them slippery.
- Some surfaces are challenging to visually interpret and then predict how they are going to behave underfoot. This is particularly likely with a mixture of surfaces, for example loose aggregate on top of a natural hoggin.

- Surfaces such as paving, resin-bound aggregates and timber boards should be selected for good slip resistance. It is important to check slip resistance values with manufacturers when selecting materials.
- Durability of materials and construction will have a major bearing on how well a path keeps its quality of access and how much maintenance and repair are needed.
- Maintenance considerations are also key. Some materials require more skill than others, and some need specialist equipment and regular attention.
- The environmental impacts of different materials should be seen as an important priority and there is an increasing range of recycled and sustainable materials available.
- Some of the main options for surface materials are shown in Table A.6a.

Tactile indicator surfaces

Tactile indicators are raised strips or other patterns incorporated in a path or trail to indicate the approach of a hazard for blind and partially sighted people. They are also referred to as hazard warning surfaces. While their use is less common in the countryside, they may be applicable in more managed landscapes to indicate a path junction, road crossing or flight of steps, for example.

- Tactile indicators should only be used where visitors would expect them, such as at a road crossing. The material and pattern used must be consistent with their recommended application and should not impact the accessibility of the existing surface, by becoming a trip hazard or giving the wrong information.
- The tactile indicator must be full path width and 800mm long. It should end no more than 400mm before the feature it is warning people about.
- Refer to guidance in the [DETR guidance on the use of tactile paving surfaces](#). Updated guidance is due to be released shortly and is currently summarised in a [Transport Research Laboratory technical annex](#).

Path edging

- Providing clear visual and tactile distinction between the path and adjoining ground is especially helpful for blind and partially sighted people.
- Hard edges should be at a level below that of the path surface to ensure that they do not create trip hazards or barriers to wheels.
- Consider the longevity of edging materials. For example, timber will degrade and recycled plastic may be a more durable option.
- No object should be placed along a path where it will reduce the required clear width of that path or create a hazard.

Drainage and crossfalls

- Good quality construction of paths and their surrounds should minimise standing water and damage from run-off, both of which can impede access.
- Crossfalls and cambers are important for water drainage, but significant slopes can cause wheelchairs and pushchairs to slew off course. They can also be unnerving for some ambulant disabled people. This can be particularly dangerous if the slope leads to open water or a road. Aim to reduce crossfalls to a maximum of 1:50.
- Gully grates and manhole covers should not normally be used on paths and trails. If these are unavoidable, ensure that the gaps between the grills of the grate are no more than 12mm wide and grills are placed at right angles to the direction of travel. Grates and covers should be flush with the ground level.

Erosion and rutting

- Path erosion can be caused by people pressure, including cyclists and horse riders, and water run-off. It is a particular issue in areas that are heavily used, on less robust surfaces and increasingly in all areas due to increasingly heavy rain downpours. It can lead to paths being difficult or unsafe to use, especially by people with mobility disabilities.
- Good construction is essential. Choosing materials that are more resistant to erosion will help reduce the need for regular repairs. Selecting materials that can be easily repaired is an option if financial resources are in place to do this.
- It is important to consider the implications of climate change on the choice of materials and management of paths. This report by NatureScot has more information: www.nature.scot/naturescot-commissioned-report-436-paths-and-climate-change-investigation-potential-implications

Maintenance and repair

Surfaces need regular maintenance to keep them in good repair and free of potholes, cracks, and other deterioration that can cause obstructions. This is critical in sustaining and sometimes enhancing, the quality of accessibility.

- Maintenance must match the original materials and specification. Topping with a larger aggregate can significantly reduce accessibility.
- It is important to maintain the path profile over time. On informal routes, crossfalls can build up through years of topping paths with new surface material. This raises the centre of the path profile and creates a steeper crossfall (camber) to either side.
- Unbound compacted aggregate paths will require more regular maintenance than semi-bound and bound materials. Ineffective practices such as filling potholes with loose material that quickly washes

out or spreading a coarse aggregate on the surface can instantly degrade a previously high-quality surface.

- Obvious lack of maintenance can result in people feeling less confident in the accessibility and safety of a route. A timely response is important.
- Ensure the surface remains free of obstacles and loose material on the surface. Even very small loose particles can make a path slippery for people. Standing water can also be a hazard, especially in the winter.
- Avoid chicken wire type mesh to improve traction on bridges, boardwalks etc. It quickly deteriorates, can cause a trip hazard and puncture tyres and dog's paws. It requires continuous maintenance to keep in good repair.

Table A.6a Surface materials

Type of surface	Advantages	Disadvantages
Natural, unbound and semi-bound surfaces		
<p>Natural</p> <p>For example, an existing sub-base material such as limestone, or a woodland floor.</p>	<p>Can be a firm and stable surface if on relatively level ground.</p> <p>Blends well with the landscape.</p> <p>Low capital cost (though may need regular maintenance).</p> <p>Minimal impact on existing landscape.</p> <p>Low environmental impact.</p> <p>Potential for involving volunteers in monitoring and repairing surfaces with the appropriate training.</p>	<p>There are limited conditions where this will provide a reliably accessible surface. In particular, accessibility will be limited in wetter periods.</p> <p>Erosion and wear will make paths less accessible and may lead to wider areas of landscape being damaged by people making alternative routes. Slopes increase the likelihood of erosion and wear.</p> <p>Local irregularities such as big stones, tree roots and water-worn channels can create obstacles.</p> <p>Regular inspections and maintenance are needed to keep routes in good repair.</p>

<p>Mown grass</p>	<p>Blends well with the landscape.</p> <p>Minimal impact on existing landscape.</p> <p>Relatively low environmental impact.</p> <p>Low capital cost (though regular maintenance).</p> <p>It can be strengthened with reinforcing mesh or mats.</p> <p>Accessibility is maximised by regular cutting and rolling so the grass is kept short and the substrate is firm and level.</p>	<p>Difficult to achieve a firm, stable, non-slip and obstacle free surface and only the very best grass surfaces are fully accessible.</p> <p>Small irregularities and obstacles can be hard to spot.</p> <p>Accessibility is greatly affected by weather conditions.</p> <p>Can crack in dry conditions and be muddy and waterlogged in wet weather. Even a little surface water can create a slip hazard.</p> <p>Regular mowing and rolling is essential. Erosion is likely on well used paths and is difficult to repair without closure.</p>
<p>Self-binding aggregates</p> <p>Including graded as-dug, hoggin and Whin dust.</p> <p>Aggregates lock together to create a firm, stable surface.</p>	<p>Provides a firm and stable surface if well-constructed.</p> <p>Aggregates can be chosen to create an attractive surface that blends well with the landscape. This is particularly important in more sensitive heritage and environmental settings.</p> <p>There are increasing examples to draw from of this material being used to good effect throughout the UK.</p> <p>Recycled materials are available.</p> <p>Relatively low environmental impact.</p> <p>Semi-permeable to water.</p>	<p>Medium capital cost.</p> <p>Needs careful selection of material and skilled construction.</p> <p>Needs good drainage to prevent surface materials being dislodged.</p> <p>Needs regular maintenance and repair but less than unbound and mown grass.</p> <p>The surface can break up as a result of encroaching vegetation, water run-off and heavy use, and this can lead to an unstable, uneven surface.</p>

Bound surfaces		
<p>Blacktop Macadam, Asphalt, Bitmac.</p>	<p>Provides a firm and stable low maintenance surface if it is well prepared and laid with edgings.</p> <p>Weathers well, and the visual impact can soften quickly. It is available in a range of colours.</p> <p>The surface appearance can be enhanced by rolling in an aggregate or gluing an aggregate to the surface.</p>	<p>High capital cost.</p> <p>Surface can become soft or sticky in very hot weather. Potholes can develop and cause an uneven surface.</p> <p>Vegetation can encroach and break the edges or can grow through the surface.</p> <p>Can be slippery for horses. It can put strain on their feet and legs if used for prolonged periods of time.</p>
<p>Resin-bound aggregate Aggregate and resin are mixed before laying to create a smooth surface.</p>	<p>Provides a firm and stable surface for people walking and wheeling.</p> <p>Less abrasive than resin-bonded surface.</p> <p>Can be water permeable.</p> <p>Recycled products are increasingly available.</p> <p>Attractive with large choice of colours.</p> <p>Relatively high durability and low maintenance.</p> <p>If well laid, provides a hard-wearing and low maintenance surface.</p> <p>New products are developing that require a shallower sub-base.</p>	<p>High capital cost.</p> <p>Requires specialist construction.</p> <p>Can be uncomfortable and slippery for horses.</p> <p>Appearance can be too 'formal' for some more natural settings.</p>

<p>Resin-bonded aggregate</p> <p>Aggregate is stuck to the surface of a binder layer.</p>	<p>Provides a firm and stable surface for people walking and wheeling.</p> <p>Attractive with large choice of colours.</p> <p>Recycled aggregates are increasingly available.</p> <p>Good anti-slip qualities.</p> <p>If well laid, provides a hard-wearing and low maintenance surface although the surface is more prone to wear than a resin-bound surface.</p>	<p>High capital cost (but lower than resin-bound surface).</p> <p>Less durable than resin-bound with greater maintenance requirement over time.</p> <p>Requires specialist application.</p> <p>Not water permeable.</p> <p>‘Sandpaper’ surface can cause more abrasions if people fall on it.</p> <p>The surface layer can be prone to becoming loose and unstable if used often by vehicles, especially for turning.</p>
<p>Resin-bound rubber crumb</p>	<p>Provides a smooth, stable surface for people walking and wheeling and for horses.</p> <p>Greater range of products available including ones that create an attractive, ‘natural’ appearance that blends well with the landscape.</p> <p>Some products use recycled rubber.</p> <p>Permeable to water.</p> <p>Higher impact-absorbing qualities reduce the risk of injury from falls.</p> <p>Material is popular for play areas and is an accessible alternative to materials like loose bark.</p> <p>Maintenance appears to be minimal and manufacturers are commonly offering over 15 years’ guarantee.</p>	<p>Requires specialist construction skills and machinery.</p> <p>Moderately high installation costs.</p>

Other surfaces		
<p>Reinforced grass</p> <p>Using plastic cellular grid and mats.</p>	<p>Relatively low-cost.</p> <p>Blends well with the landscape and useful where a hard surface is not appropriate.</p> <p>Low environmental impact, water permeable.</p> <p>Important to choose anti-slip materials.</p> <p>Recycled options are increasingly available.</p> <p>Rubber grass mat works well and can last for years.</p>	<p>Only effective in relatively level locations where grass will grow well. Not reliable in heavily shaded areas for example.</p> <p>Regular grass cutting required to maintain an accessible surface.</p> <p>When the mat starts to deteriorate it can be difficult and expensive to remove.</p> <p>It can be damaged by grass maintenance machinery. Edges must be dug in which is time consuming.</p>
<p>Brick and paving</p>	<p>Can provide a firm surface, although more suited to more formal landscapes.</p> <p>Sustainable and recycled options are available.</p> <p>Good durability and low maintenance, but high initial costs.</p> <p>Can be semi-permeable.</p>	<p>Must be well-constructed to ensure that pavers are evenly laid and do not move.</p> <p>Relatively expensive installation.</p> <p>Can be visually inappropriate in more natural settings.</p> <p>Pavers can move over time creating irregularities in the surface, obstacles and trip hazards.</p>

<p>Timber, recycled plastic and composite board</p>	<p>Provides a firm and stable surface, most often used for boardwalks.</p> <p>Slip-resistant composite boards generally require less frequent surface maintenance.</p> <p>Sustainable and recycled options are available.</p> <p>May be the only realistic option in wet areas.</p> <p>Can be visually attractive and blend with the landscape, or can appear to ‘formalise’ a route, depending on the materials and design.</p> <p>Higher slip-resistant products (often with high-grip strips) are available. Manufacturers can provide the slip resistance value.</p>	<p>High capital costs, especially with the rise in timber prices.</p> <p>Timber requires regular maintenance to ensure the surface does not become slippery or uneven. Without anti-slip strips, the surface can become extremely slippery in the wet or when algae builds up.</p> <p>Wood can warp and boards can become uneven, creating potential trip hazards.</p> <p>Regular safety checks are essential for timber and composite boards to ensure they remain structurally sound.</p> <p>Never use chicken wire to prevent slipping. It breaks up and can puncture mobility scooter tyres and dog’s paws and create a trip hazard.</p>
--	--	--

<p>Concrete</p>	<p>Provides a firm and stable surface.</p> <p>A lightly textured finish can help to prevent it becoming slippery when wet or with a build-up of algae.</p> <p>Quick to install.</p>	<p>Relatively high capital cost.</p> <p>Low environmental credentials.</p> <p>Needs a well-prepared base with sufficient depth, and often also needs reinforcement mesh. This will improve its weight bearing capacity, prevent cracking and extend the period when little maintenance is required.</p> <p>Will not always be appropriate in a countryside setting, but the visual impact may soften with time. Tends to be used for ramps and its poor sustainability credentials make it less popular generally.</p> <p>Can be slippery for horses. It can put strain on their feet and legs if used for prolonged periods of time.</p>
------------------------	---	---



Examples of good practice

Scotland's National Paths Demonstration Site, Paths for All

This site in Scotland's Rural College Oatridge Campus, West Lothian demonstrates good practice in path construction and showcases different surface materials as well as features such as accessible gates, seats, bridges and signs. It helps anyone involved in path design and access improvements.



Paths for All

If you are too far away to visit, there is a video and other materials on the Paths for All website: www.pathsforall.org.uk/community-paths/cmp-the-national-demonstration-site



Barnet Environment Centre

A path made from resin-bonded rubber crumb in a community environment site in Barnet. Credit: Barnet Environment Centre



Sensory Trust

A path is close-mown to create access through a wildflower meadow. Short grass can be reasonably accessible on relatively firm, dry ground. Credit: Sensory Trust



Further guidance

Outdoor Access Design Guide, Paths for All and NatureScot www.pathsforall.org.uk/resource/outdoor-access-design-guide

Surfacing guide for path projects, Paths for All www.pathsforall.org.uk/resource/surfacing-guide-for-path-projects---updated

Lowland Path Construction Guide, Paths for All www.pathsforall.org.uk/resources/resource/lowland-path-construction-guide

Accessible Outdoor Places Guide, Disability Sports Northern Ireland www.dsni.co.uk/wp-content/uploads/2021/07/Guide-5-Accessible-Outdoor-Places-Design-Guidelines.pdf

A.7 Gradients and ramps

Linear gradients are one of the most significant barriers limiting access to paths and routes. While it is not always possible to change a specific gradient, it is often possible to reduce its impact. For example, by improving the quality of the surface, minimising crossfalls, adding handrails and providing opportunities to rest.

Gradients impact a much wider range of people than often assumed. It is well understood that gradients can be physically challenging, but they can also be unnerving, especially if combined with a surface that gives limited grip. It is one of the reasons why some people prefer steps to ramps and why the look and feel of ramps and slopes is important, not just their functional details.

These challenges do not impact everyone equally and it is important to recognise that some disabled people can negotiate more challenging grades. Applying the principle of Least Restrictive Access is important here, recognising that some improvements will still make a difference to routes that are more challenging. For example, widening a gate may be all that is required to open up a route to a larger mobility scooter that can safely negotiate a steeper grade.



What does inclusive practice look like?

- ▶ All work complies with statutory regulations and British Standards where they apply.
- ▶ Ramps and slopes have good quality surfaces and minimal crossfalls.
- ▶ Ramps and slopes are appropriately detailed, for example with handrails on both sides. They are well-integrated into the landscape, using sensitive materials and design.
- ▶ Regular maintenance keeps ramps and slopes in good repair and identifies priorities for improvement.



Design guidance

General considerations

- The steeper the gradient, the more people it will impact, therefore the ambition for access improvements should be to reduce gradients as much as possible when making new routes and upgrading existing ones.
- Where gradients can't be altered, it is important to apply a least restrictive approach to minimise their impact. For example, providing seats and perches alongside, improving the surface (loose materials on slopes are much more challenging), and adding features like handrails.
- Paths must be step-free if they are to be accessible to wheelchair, mobility scooter and adaptive bike users, however some ambulant

disabled people prefer steps. Therefore, where possible provide both steps and ramps. If a single choice must be made, choose ramps.

- Excessive crossfalls can cause as much difficulty to wheelchairs, pushchairs and ambulant disabled people, as gradients along the length of a path. On informal routes these can build up through years of topping paths with new surface material. This is poor practice as it raises the centre of the path profile and creates a steeper crossfall to either side.

Seating

- Prioritise seating as a way of providing rest opportunities alongside a gradient.
- With ramps, aim to locate seats on landings but take care not to reduce the usable width of the ramp.
- See Section B.1 for more guidance on seating.

Gradients

- A gradient less than 1:60 (1.7%) is considered level.
- A gradient between 1:60 (1.7%) and 1:20 (5%) is considered gently sloping. A slope at the steeper end of this range can still be challenging when sustained over distance and the incorporation of level areas and seats is important.
- A gradient steeper than 1:20 (5%) is considered a ramp and will need to be detailed accordingly (see below).
- Providing public information about gradients is essential so that people can judge which are suitable for them. This is important because different wheelchairs and mobility scooters have different capabilities in relation to gradients.
- Avoid abrupt changes of gradient and aim for smooth gradual changes.

Cambers and crossfalls

- The maximum crossfall and camber should be no greater than 1:50 (2%). Crossfalls in excess of this, especially when combined with a linear path slope, can present difficulties for many disabled people.
- Maximum crossfall and camber for more remote routes is 1:35 (2.7%), recognising that a lower crossfall will benefit most users.

Ramps

- A gradient greater than 1:20 (5%) is considered a ramp and should be designed accordingly. A ramp gradient should not exceed 1:12 (8%).
- Level landings or platforms provide important resting points for wheelchair users, ambulant disabled people and people with low energy. Landings should be at least 1500mm long. They should be provided at the start and end of a ramp, and at regular intervals if a ramp extends beyond the recommended limit. To calculate the gradient and distance between landings refer to Table 3 in BS 8300-1:2018.

- Building regulations and standards recommend that ramps should not be longer than 10m or rise more than 500mm without a level platform. This frequency of level platforms may be difficult to achieve in remote countryside.
- A handrail on both sides of a ramp is important especially for more challenging sections of path. Take care that any handrails do not reduce the clear width of the path.
- A firm, slip-resistant surface in dry and wet conditions is essential. Loose materials should be avoided as they are particularly hazardous on a slope.
- An upstand of 100mm high along each edge of a ramp will act as a wheel stop and indicator for blind and partially sighted people who use a long cane.



Further guidance

BS 8300-1:2018: Section 10.2 Ramps and slopes

shop.bsigroup.com/products/design-of-an-accessible-and-inclusive-built-environment-external-environment-code-of-practice/standard

Scottish Government, Building Standards technical handbook 2017: 4.3 Stairs and ramps www.gov.scot/publications/building-standards-technical-handbook-2020-domestic/4-safety/4-3-stairs-ramps/

Paths for All and NatureScot, Outdoor Access Design Guide www.pathsforall.org.uk/resource/outdoor-access-design-guide

Disability Sports Northern Ireland, Accessible Outdoor Places Guide www.dsni.co.uk/wp-content/uploads/2021/07/Guide-5-Accessible-Outdoor-Places-Design-Guidelines.pdf

A.8 Steps

Steps are a complete barrier to wheelchair and scooter users and challenging to many ambulant disabled people and parents with pushchairs. Therefore, steps and alternative step-free routes should always be highlighted on public information.

Steps should be designed to maximise their safety and usability, for example by paying careful attention to surfaces, handrails and step detailing. Some ambulant disabled people find steps easier and safer than ramps so the ideal is to provide both where possible.

In remote countryside it may not be possible to meet all these recommendations, but care should still be taken to make steps as safe and easy as they can be. For example, by ensuring that all risers and treads are uniform or by ensuring the surface is uniform and slip resistant.



What does inclusive practice look like?

- ▶ All work complies with British regulations and standards where they apply.
- ▶ Steps have good quality surfaces, handrails on both sides and consistent riser and tread dimensions throughout a flight.
- ▶ Single steps are avoided as they are easy to overlook.
- ▶ Steps are regularly maintained.
- ▶ Steps have contrasting nosings so the individual steps can be easily distinguished.



Design guidance

Ease of use

- Some ambulant disabled people find steps easier and safer than ramps, so provide both where possible. If there is only one option, then ramps should take precedence.
- Avoid single steps and level changes less than 150mm. Single steps and small changes can be trip hazards as they are often not seen or expected. Generally, a flight of steps should have at least three steps.
- Provide a handrail on both sides (see Section A.9).

Consistency

- Each step in a series should have the same tread depth and riser height so people can rely on consistency throughout.

Consistent tread and riser dimensions is important

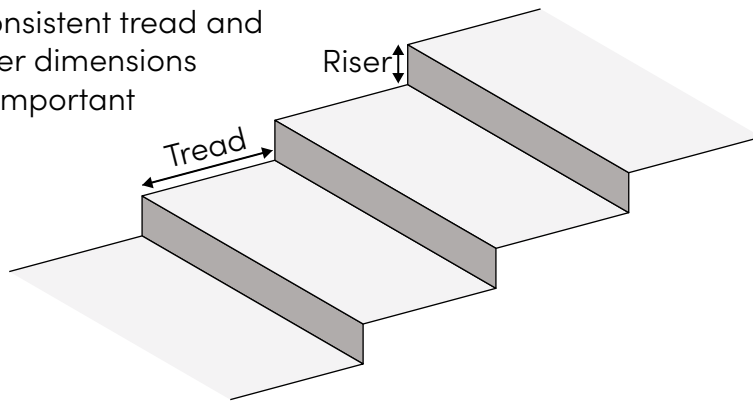

Dimensions

- Recommended maximum riser height: 150-170mm. Tread depth: 300-450mm.
- A flight of steps should have a clear width of at least 1200mm, and a minimum 1000mm between handrails.
- If a flight is wider than 2000mm it should be divided by a handrail down the middle.
- A series of steps should not continue beyond a total rise of 2000mm.
- Provide a clear, level area 1500mm x 1200mm at the top and bottom approaches to steps so people can pass easily.
- A light front-fall on a step tread is important for water drainage but should not exceed 1:50.

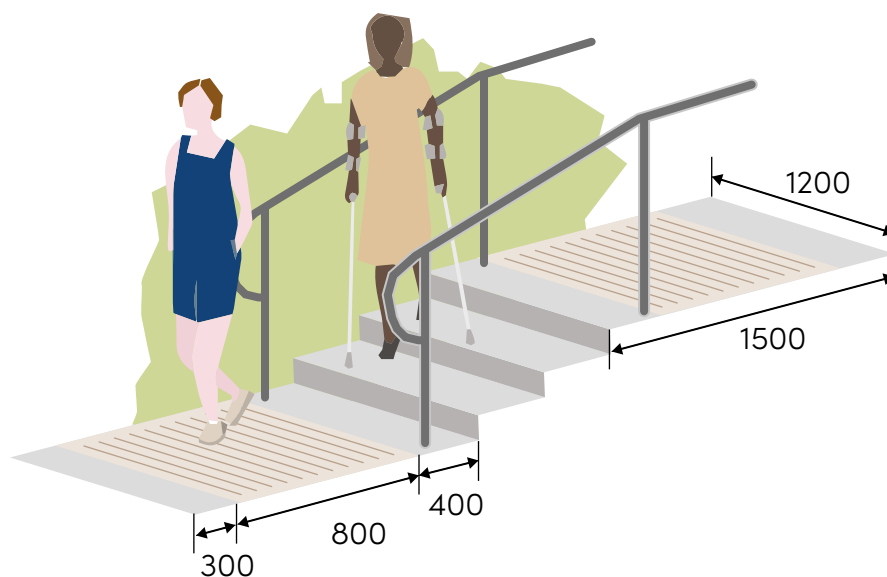

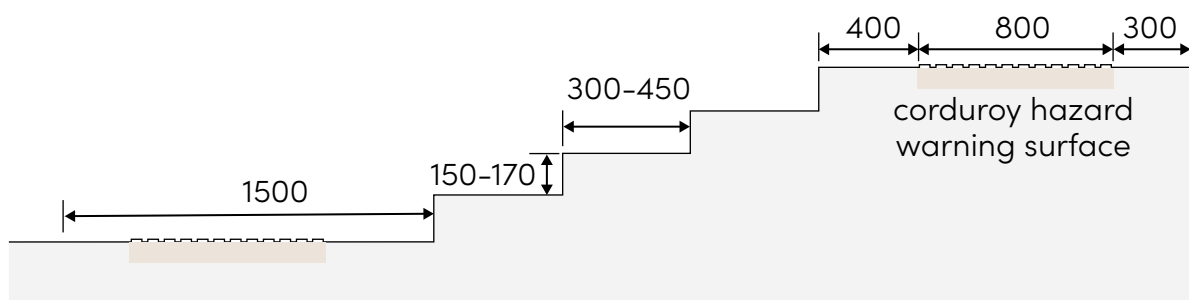

Indicators

- Corduroy hazard warning surface is required on the top and bottom approach to steps as warnings to blind and partially sighted people (see sheet A.6).
- Steps should be clearly signed if they are not obvious.
- Where appropriate, add supplementary lighting to help people use steps safely in low light conditions.

Nosings

- Step nosings that contrast in colour with treads and risers add safety for everyone, especially people who are blind or partially sighted. This contrast can be achieved by using a different material or adding a contrasting strip to the nosing.

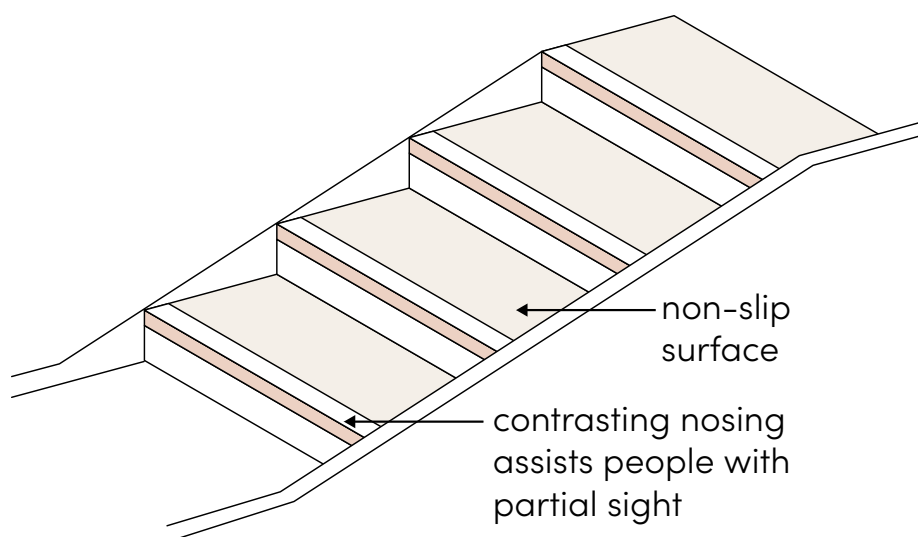

- Step nosings should be highlighted with a 50-60mm tonally-contrasting strip on both the tread and riser to ensure this important feature is noticeable when ascending and descending a flight of steps.
- A smooth, rounded nosing is preferred.

- Protruding nosings and open treads should be avoided as they are a trip hazard and some assistance dogs may refuse to climb steps with open treads.

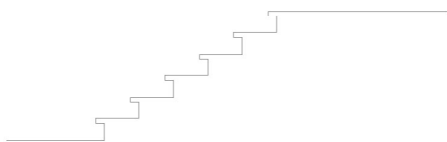
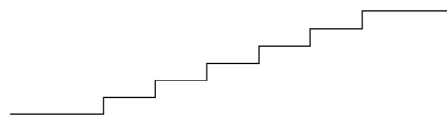

Materials

- Step treads and nosings should be constructed with a slip resistant, slightly textured material, which remains slip resistant when wet or muddy.

Maintenance

- Regular checks are essential to ensure that steps and handrails are kept in good repair and steps are kept clear of debris. This includes ensuring there is good drainage to the front of the steps.



Further guidance

BS 8300-1:2018: 10.1 Steps and stairs

shop.bsigroup.com/products/design-of-an-accessible-and-inclusive-built-environment-external-environment-code-of-practice/standard

Scottish Government, Building Standards technical handbook 2017: 4.3 Stairs and ramps www.gov.scot/publications/building-standards-technical-handbook-2020-domestic/4-safety/4-3-stairs-ramps/

Paths for All and NatureScot, Outdoor Access Design Guide www.pathsforall.org.uk/resource/outdoor-access-design-guide

Disability Sports Northern Ireland, Accessible Outdoor Places Guide www.dsni.co.uk/wp-content/uploads/2021/07/Guide-5-Accessible-Outdoor-Places-Design-Guidelines.pdf

A.9 Handrails

Handrails provide support to people when they are climbing or descending steps and ramps, as an aid to balance or to lean against to rest. Sometimes they also protect someone from falling over an edge or entering an area that is unsafe. They are an important aid and a crucial safety feature for everyone.



What does inclusive practice look like?

- ▶ Handrails are provided on both sides alongside steps and ramps, and in other places where they provide valuable support.
- ▶ In more informal landscapes, opportunities are sought for providing secure handholds and rails by making use of existing features, such as fence posts.



Design guidance

General considerations

- Handrails should be seen as an important part of step and ramp design. They are especially important for challenging sections of pathways that could otherwise be difficult and unsafe to negotiate.
- Handrails should be prioritised for intensively managed and regularly used landscapes. They may be covered by building regulations and standards if they relate to a building.
- In remote countryside, there may be features that people can use as handholds such as posts and trees.
- Handrails on both sides allow for people to pass each other and individuals with one strong arm.
- It is essential that rails are securely fastened and strong. Loose or damaged handrails are dangerous, especially where they also serve a protective role alongside a drop or hazardous area.
- Durability and maintenance are important considerations when selecting materials for handrails.
- Handrails should not impinge on the minimum clear width of the path.

Materials

- Materials should be comfortable to grip, not abrasive or splintering, or prone to retaining cold or heat.
- Timber is often used in countryside settings because of its natural look and feel. Choose wood for rails that is durable and that doesn't split or splinter. Also consider the longevity of wooden support posts. Timber should have FSC accreditation and be sustainably sourced, especially if using hardwood such as UK sourced oak.

- Metal is long-lasting and may be more appropriate in formal landscapes. Materials with low thermal conductivity, such as aluminium, or metal rails with a protective coating should be selected to reduce extremes of cold or heat. For support posts and handrails, metal is a more durable option than timber.
- Upcycled and recycled materials are increasingly available for both rails and support posts. For example, recycled plastic and salvaged and repurposed wood and metal materials.

Positioning

- A top rail at 900-1000mm from the pitch line of the ramp or step.
- A mid rail at 600-750mm considers wheelchair users, children and people of short stature.
- A bottom rail at 100mm will provide extra reassurance as a wheel stop for wheelchairs, mobility vehicles and pushchairs.
- Continue the rail for 300mm beyond the end of the bottom of the ramp or flight of steps. This ensures that people find support before they start or finish using the ramp or steps. This also serves as an important guide to blind and partially sighted people. Continue the rail along landings on multiple ramps or flights of steps.
- Ensure the end of the rail does not create a hook point for clothing or harnesses. This can be achieved by curving the end of the rail downwards or aligning it with a support post.
- If the rails is against a fence or wall, provide 50-75mm clearance to give room for fingers to grip.
- A wall, fence and vegetation behind a rail should be non-abrasive, including plants without any thorns.

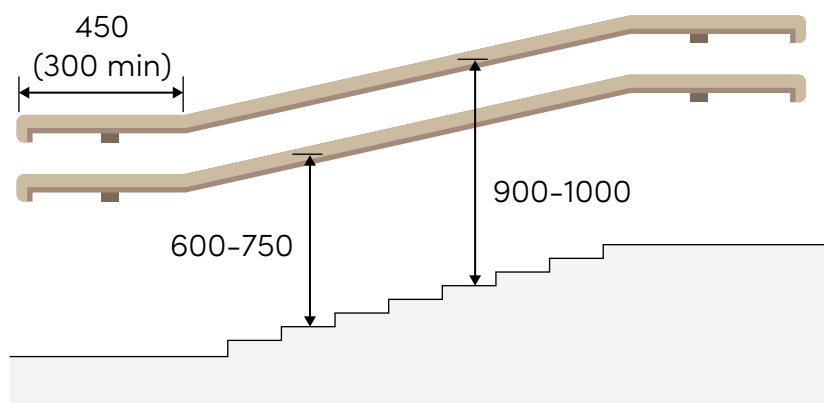

Rail detail

- Profile: Oval or circular is easier to grip.
Top rail: 40-50mm diameter.
Lower rail: 25-32mm diameter, graspable by children.

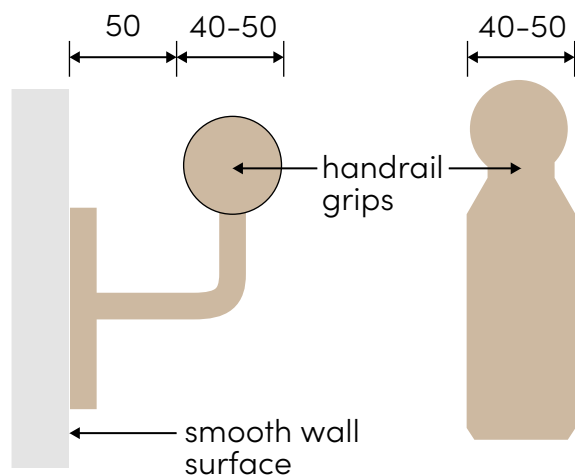

- Visual contrast: Choose materials that provide good tonal contrast between the handrail and its background as many blind and partially sighted people will benefit from these contrasts.
- Regular checks and repairs are essential to ensure that handrails and rails remain secure and functional, and that their use is not impeded by overgrowing vegetation or obstacles.

Creative options

- Handrails and rails can be an opportunity to add interpretation, for example by adding braille or pictograms. This obviously depends on context, but it can be a simple way of adding more interest by using infrastructure that is also serving a functional role.
- There is also scope to add textural interest and to add more sensory interest, such as carvings that form part of a sensory trail. This can be a good way of inviting local communities to get involved.



Examples of good practice



Sensory Trust

Curving the handrail at the end reduces the risk of catching clothes, which is especially important for blind and partially sighted people. Stainless steel is a relatively expensive option and may not suit all settings, but it is long-lasting, and it remains comfortable to touch as it doesn't retain excessive heat or cold.



istock.com/Tham Kee Chuan

Handrails can be an opportunity to add braille information.



Further guidance

BS 8300-1:2018: 9.3 Handrails to ramped and stepped access provision shop.bsigroup.com/products/design-of-an-accessible-and-inclusive-built-environment-external-environment-code-of-practice/standard

Scottish Government, Building Standards technical handbook 2017: 4.3 Stairs and ramps www.gov.scot/publications/building-standards-technical-handbook-2020-domestic/4-safety/4-3-stairs-ramps/

Paths for All and NatureScot, Outdoor Access Design Guide www.pathsforall.org.uk/resource/outdoor-access-design-guide

Disability Sports Northern Ireland, Accessible Outdoor Places Guide 1.6 Handrails www.dsni.co.uk/wp-content/uploads/2021/07/Guide-5-Accessible-Outdoor-Places-Design-Guidelines.pdf

A.10 Gates, gaps and stiles

Gates are a common barrier to access in the countryside. While many gates are needed for stock or vehicle control they can be too narrow for wheelchairs, adaptive bikes and mobility scooters to pass through. Gates can be heavy or awkward to move or have latches that are difficult to use.

Following the least restrictive approach, it is important to consider if a gate can be removed, or if a bollard or chicane can be used. If the gate must be retained, the priority should be to explore options for improving its accessibility.

Stiles are a complete barrier to wheelchair, mobility scooter and adaptive bike users, horse riders, families with prams and many ambulant disabled people. They should be replaced by a gap or gate wherever possible, or a reasonable alternative route provided. This guide does not endorse the installation of new stiles.

British Standard 5079:2018 is the key reference for any work relating to gaps, gates and stiles. The standard takes account of the needs of landowners and land managers while aiming for as little restriction on users as possible.



What does inclusive practice look like?

- ▶ All work complies with BS 5079:2018.
- ▶ There is a policy of replacing stiles and gates with gaps wherever possible, and of upgrading gates to accessible designs where they cannot be removed.
- ▶ An action plan prioritises gate improvements such as more accessible handles and extending manoeuvring spaces for wheelchairs, mobility scooters, cycles and horses.
- ▶ Gates are easier to use because of improvements such as more accessible handles and greater manoeuvring space for wheelchairs, mobility scooters, bicycles and horses.
- ▶ Regular maintenance keeps gates operating freely and as designed to do, for example by clearing brambles and nettles.



Design guidance

General considerations

- The least restrictive option is to replace gates that are no longer required with a gap. If a gate is required, then the least restrictive option is to introduce a gap alongside or to provide an alternative way through within a short distance.
- Where gates are required, aim for the most accessible options in gate design and associated details such as opening mechanisms.

- An ambition to prevent some types of use such as motorbikes can reduce accessibility for others, such as larger mobility vehicles, and it is important to explore options that provide a best compromise.
- Any gate design must follow British Standard BS 5709:2018: Gaps, gates and stiles.
- Ensure there is no barbed wire or electric fence within 1000mm of the structure or within the maneuvering space and no injurious plants within 500mm.
- Potential user needs include the following: pedestrians and people with wheelchairs, electric mobility scooters (eg Trampers), pushchairs, cycles (including adaptive bikes and tricycles) and horses. The choice of gate will determine who is able to use it.

Surfaces

- Pay attention to the quality of the path surface at gates as these areas receive the greatest level of wear.
- For one-way opening gates, a surface of equal quality to that of the path should be maintained for at least 2000mm from the gate on its opening side to maximise usability.

Pedestrian path widths

- 1100mm minimum clear width for gaps and gates conforms with BS 5079:2018 and applies to England, Wales and Northern Ireland.
- This has been increased to 1500mm minimum clear width in Scotland and aligns with the Land Reform Act (Scotland) 2003.

Bridleway widths

- 1525mm minimum clear width for gaps and gates.
- A substantial maneuvering space should be provided either side of bridle or field gates to allow users to operate a latch and to move through. Some horses and mobility vehicles need at least 4m x 4m maneuvering space.
- More guidance on accessible gate design for horses at www.bhs.org.uk/advice-and-information/free-leaflets-and-advice

Space by gates

- Space by gates allows people to manoeuvre to open a gate, move through and close it. It is identified as a requirement of BS5709:2018 but specific dimensions are not given because of the wide variety of structures, contexts and users potentially involved. However, the standard does highlight that a great deal more space is needed than is commonly assumed.
- Even when provided, these spaces can be reduced by encroaching vegetation or placement of objects such as temporary signs and bins.

This design detail therefore relies as much on good management as on the initial design.

- Space should allow path users to operate the latch (if fitted), pass through the gateway and close it.
- One-way gates need more maneuvering space than two-way because people will need to open the gate towards them and then move around it. People using larger mobility vehicles, adaptive bikes and horses need a 4m diameter space.
- It is recommended that you consult with some potential users beforehand to ensure that access improvements will be effective. Professional advice and looking at examples of good practice in other places is valuable.

Ease of opening

- For maximum accessibility gates should be hinged to open both ways where possible.
- The force required to open and close any gate should not exceed 18 Newtons (this can be measured with a door closing force test gauge).

Latches and levers

- Latches or other mechanisms should be usable from both sides. Poor latches are likely to be an absolute barrier to people with reach or dexterity disabilities.
- Latches should be visible from both sides with good colour contrast to show the working parts of the gate (especially important for blind and partially sighted people).
- Latches should be between 600 - 1200mm high.
- Self-closing gates should take at least 8 seconds to close to give people time to get through.
- If unusual mechanisms are employed, then information on their operation should be easy to understand.
- The latch handle should be at least 100mm long and 20-30mm thick with a minimum clearance of 30mm.

Keys

- The RADAR National Key System (also known as NKS) is most often used to control access to public toilets but it is sometimes used for gates, especially to allow large mobility kissing gates to be opened more fully for mobility scooters. The intention is usually to give access to disabled people while controlling stock or excluding other users eg motorcyclists.
- The key system limits and can exclude accessibility for disabled people who do not have RADAR keys, or do not expect to use them in these circumstances. The locks are difficult to operate by people with limited dexterity.
- It is important to explore alternative options that avoid the use of keys and padlocks for gates.

Maintenance

- Regular checks and repairs are essential to keep gates in good working order, keeping surfaces intact and removing encroaching vegetation. RADAR locks need regular maintenance too, especially ones that are not regularly used.



Examples of good practice

Scotland's National Paths Demonstration Site, Paths for All, Scotland

This site in Scotland's Rural College Oatridge Campus, West Lothian demonstrates good practice in path construction and design, including different types of accessible gates. If you are too far away to visit, there is a video and other materials on the Paths for All website: www.pathsforall.org.uk/community-paths/cmp-the-national-demonstration-site



Further guidance

British Standard BS 5709:2018 Gaps, Gates & Stiles (full version) www.shop.bsigroup.com/products/gaps-gates-and-stiles-specification/standard

Understanding the British Standard for Gaps, gates and stiles (free, simplified version) www.centrewire.com/wp-content/uploads/2019/09/Pittecroft-Trust-BS5709-2018-explained.pdf

Scottish Government, Building Standards technical handbook 2017: 4.3 Stairs and ramps www.gov.scot/publications/building-standards-technical-handbook-2020-domestic/4-safety/4-3-stairs-ramps/

Disabled Ramblers, Man-made barriers and Least Restrictive Access disabledramblers.co.uk/man-made-barriers-and-least-restrictive-access/

Paths for All and NatureScot, Outdoor Access Design Guide www.pathsforall.org.uk/resource/outdoor-access-design-guide

Disability Sports Northern Ireland, Accessible Outdoor Places Guide www.dsni.co.uk/wp-content/uploads/2021/07/Guide-5-Accessible-Outdoor-Places-Design-Guidelines.pdf

A.11 Boardwalks and bridges

Boardwalks and bridges can provide a wonderful opportunity for people to get closer to rivers and wetlands, and boardwalks can be attractive, low impact structures to place in more sensitive areas of landscape. However, both can present barriers to access if they are not carefully designed. Poor design, or lack of upkeep, can cause slippery, narrow pathways, uneven boards, hazardous open edges or steep grades on bridges.



What does inclusive practice look like?

- ▶ Safety is heightened by secure, well-maintained edging details, including bridge parapets and edging boards along a boardwalk.
- ▶ Viewing heights from bridges are maintained by careful detailing of rails.
- ▶ Surface improvements and regrading works on paths leading to a bridge can enhance the accessibility of a bridge.
- ▶ Regular checks and repairs are critical to maintain good accessibility of boardwalks. Bridges should be subject to more formal and regular inspection.



Design guidance

Dimensions

- Width should be judged according to expected level of use, width of connecting paths, location and whether it will be one-way or two-way.
- A minimum clear width between handrails or edging boards of 2000mm will allow for two-way traffic with no need for passing places.



- If the level of use is expected to be low, the alternative is to include passing places in a 1200mm wide boardwalk. It should have passing places at least every 100m or more frequently if visibility is restricted.
- The join of a boardwalk with another surface should avoid a level change greater than 5mm high.

Materials

See Section A.6 for information about timber and composite boards.

Detailing

- Access and egress should be ramped, not stepped, and care should be taken to ensure that where the boardwalk meets an unbound or semi-bound surface there is no change in level which could cause a trip hazard.
- To permit drainage, it is good practice to lay the deck with gaps between the individual boards. The gap between boards should not be greater than 12mm.

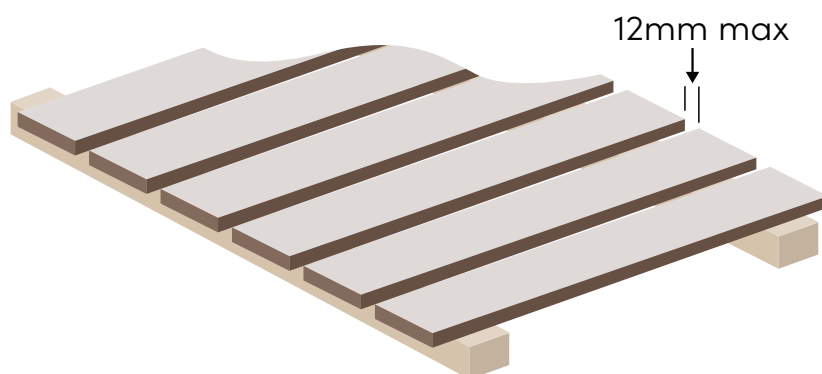

- Boards must be laid at right angles to the direction of travel otherwise wheels or mobility canes may become caught between them.

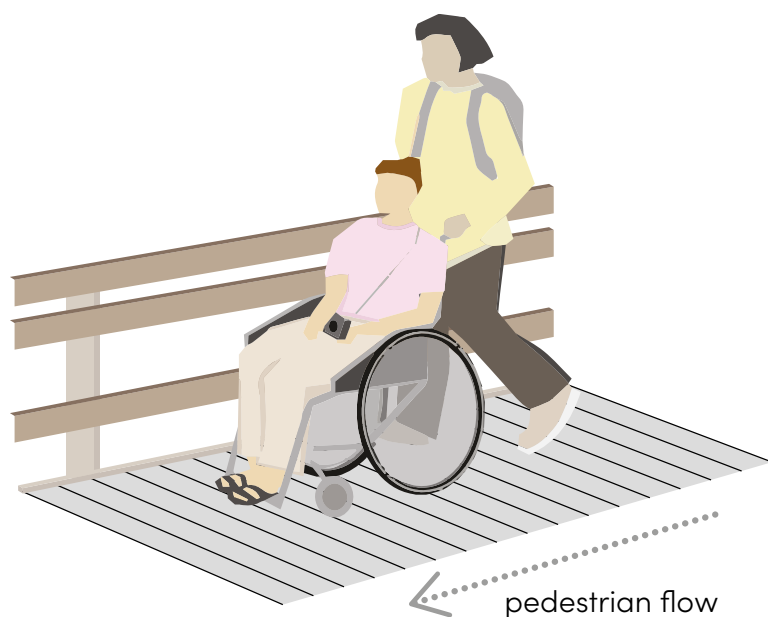

Safety

- Boardwalks should have edging, minimum 75mm high, that acts as an important wheel stop for wheelchairs and pushchairs, and an indicator for blind and partially sighted people.

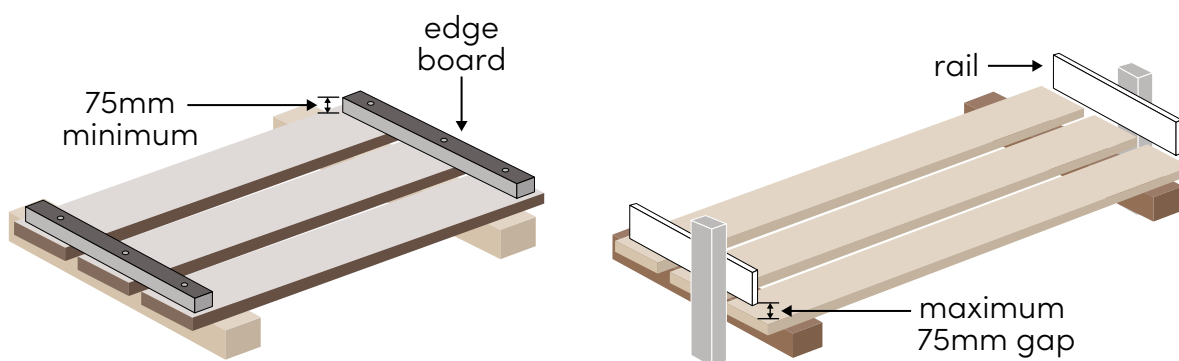

- Where these structures require side rails due to the surrounding environment and height above ground, the specification should conform with the appropriate safety requirements. Allow for views over or through for wheelchair users, children and people of various heights.
- Handrails provide valuable support. Aim to integrate handrails with the side rail design, see Section A.9.
- The weight-bearing capability should be sufficient so that boards are not deflected or broken by use. Boards that are not properly secured are hazardous. The whole structure must be stable.
- Chicken wire must never be used to improve grip as it soon breaks up and the sharp ends can puncture the tyres of mobility scooters or injure the paws of dogs.



Sensory Trust

Features

- Boardwalks, like other routes, should have passing places, rest points and seating which will require extra width and space.
- The surface of bridges and boardwalks should be level, smooth and free of any trip hazards.

Maintenance

- Good maintenance is essential to keep boardwalks in good repair. Pay particular attention to where the surface material of the bridge or boardwalk meets the connecting path and ensure that this remains level.



Examples of good practice



Sensory Trust

An elegant boardwalk layout with regular widenings. However, the use of chicken wire to add grip is strongly discouraged because it can puncture wheelchair tyres and cause a trip hazard.



Able2Adventure

Careful attention to detail is important to ensure that there is a level transition from the adjoining path onto the boardwalk.



Further guidance

Disability Sports Northern Ireland, Accessible Outdoor Places Guide section 1.2.11 page 35 - Boardwalks and bridges

www.dsni.co.uk/wp-content/uploads/2021/07/Guide-5-Accessible-Outdoor-Places-Design-Guidelines.pdf

Paths for All and NatureScot, Outdoor Access Design Guide – section 7 page 56

www.pathsforall.org.uk/resource/outdoor-access-design-guide

Paths for All, Path Bridges Guide

<https://www.pathsforall.org.uk/resources/resource/path-bridges>

A.12 Cycle access

Cycling is enjoyed by many people as a form of recreational activity, physical exercise and for some a principal way of getting around. The development of a range of adaptive bikes (also known as adapted bikes) is opening up greater opportunities for a wider diversity of people to participate, including people with a wide range of experience, confidence and ability.

Cycling can be an important aid to mobility and can give people the chance to travel independently. This can only happen if the equipment is available, and adaptive bikes can be expensive and therefore not accessible to people with limited income. It also requires infrastructure that is inclusive so that it supports safe cycling by disabled people, older people, people who aren't very confident, and children.



What does inclusive practice look like?

- ▶ Inclusive cycling activities are supported on site.
- ▶ Adaptive bikes are available for hire.
- ▶ Associated infrastructure eg accessible toilets and changing facilities are provided.
- ▶ Cycling routes and their accessibility are shown in visitor information.
- ▶ Multi-user routes are designed to ensure clear and safe use by different users.



Design guidance

General considerations

- Availability of adaptive bikes will widen options in a cycle hire facility, for example, wheelchair-adaptive bikes and trikes that offer greater stability.
- Organised activities can encourage people who are new to cycling or who enjoy cycling as a group activity.
- Associated infrastructure such as accessible toilets and changing facilities is important.
- Visitor information should identify the options on offer and include details about the accessibility of the equipment and site or route.
- There is a range of grading systems in place for cycling routes, for example using colours to indicate different levels of challenge. These can be a useful guide for the more experienced cyclist although may be less familiar to others. More detailed information is always helpful so that people can best judge what suits their particular needs.

Location

- New cycle routes should connect with wider existing local cycleways and networks such as the National Cycle Network.
More information: www.sustrans.org.uk/national-cycle-network
- Careful management of shared routes is essential to protect the safety of cyclists as well as other users.
- Designated cycling routes are preferred to minimise conflict with pedestrians and other users, either marked as part of a route or as a separate cycleway.
- Busy and more physically challenging routes, such as mountain bike trails, should be separate from walking trails.
- Accessible cycle routes should be close to parking and accessible toilets and served by accessible routes.

Inclusive cycling

- Shared routes should include tactile markings at the start and end to indicate the safe section to blind and partially sighted pedestrians.
- A boundary line between cycling and pedestrians should include a continued raised strip along the entire length of 60mm high.



Examples of good practice



Experience Community

A growing range of adaptive equipment is opening up cycling to disabled people.



Natural Resources Wales

Dedicated cycle routes are an opportunity to design widths and surfaces specifically to suit cyclists.

Cycling Without Age is a global movement that uses trishaws as an accessible means of older people cycling. It enriches and enhances lives and enables older people to be an active part of their community. It started in Denmark and is now represented in 52 countries. Cycling Without Age Scotland runs throughout Scotland.

cyclingwithoutage.scot/

PEDALL provides inclusive cycling in the New Forest and makes cycling available to all people no matter what challenges they may face. They provide a range of equipment and the forest has paths of different length and character so people can choose what best suits them.

www.pedall.org.uk/



Further guidance

Sustrans and ARUP, Cycling for Everyone: A guide for inclusive cycling in cities and towns www.sustrans.org.uk/media/7377/cycling_for_everyone-sustrans-arup.pdf

Sustrans, guidance and information on cycling and related infrastructure www.sustrans.org.uk/

Wheels for Wellbeing, a guide to inclusive cycling - fourth edition wheelsforwellbeing.org.uk/updated-guide-to-inclusive-cycling/

Cycle infrastructure design. Department of Transport Local Transport Note 1/20, July 2020 assets.publishing.service.gov.uk/government/uploads/system/uploads/attachment_data/file/951074/cycle-infrastructure-design-ltn-1-20.pdf

Cycling by design, Transport Scotland and Sustrans, 2021 www.transport.gov.scot/media/50323/cycling-by-design-update-2019-final-document-15-september-2021-1.pdf

Roads for All – good practice guide for roads. Transport Scotland's requirements for inclusive design in the construction, operation and maintenance of road infrastructure, 2013 www.transport.gov.scot/publication/roads-for-all-good-practice-guide-for-roads/

A.13 Horse riding

Horse riding is enjoyed by many as a recreational activity, and by some as a means of transport. It can be someone riding from home or local stable, taking a horse to a destination by car and trailer, or joining in with a group activity. Many disabled people have learnt to ride and enjoy the support provided by Riding for the Disabled activities across the UK.

Approximately 75% of horse riders are female and 34% are children. Riding can continue to be enjoyed into older age and it can provide a means of exploring the outdoors by people who find walking difficult. Providing safe and accessible horse riding relies on routes close to home, opportunities to park and set up at destinations further afield, and availability of group activities. Any plans to improve existing path networks, or to introduce new routes, should take into account horse riding and carriage driving as important uses.



What does inclusive practice look like?

- ▶ Horse riding and carriage driving are recognised as important activities and means of travel. They are supported in the planning of outdoor access infrastructure.
- ▶ An integrated network of multi-use routes provides access to horse riders as well as people walking or wheeling by bicycle, wheelchair or scooter.
- ▶ Horse riders have access to safe off-road routes and car parks with space for horse boxes, and these are well promoted.
- ▶ Group horse riding activities are inclusive and engage a wide diversity of people.



Design guidance

General considerations

- Organised group activities are a good way of supporting people who are new to horse riding or providing opportunities for people to enjoy a more sociable experience.
- Visitor information should identify the opportunities on offer, such as car parks with space for horse boxes and trailers and routes that are open to horse riding and carriage driving.
- Gates should be possible to open and close without dismounting but you might consider installing mounting blocks (see Section A.10).
- In parking areas, space for horse trailers should be clearly marked and with enough space to unload away from other car park users.
- Dedicated spaces are important for riders to leave their horses, for near a picnic spot, café or toilets, and while unloading horses in a car park.

- Minimum recommended width of bridges 1500mm (for up to 3m span), preferred minimum 2000mm (for 3–8m span) and 4m for more than 8m span.
- Parapet heights: top rail at 1250mm and 1600mm. Use horizontal rails rather than vertical infill and a kickboard of minimum height 250mm.

Location

- The safety of horses and riders is maximised by routes that are not shared with cars. Where possible, routes that are open to horse riding should connect with wider existing multi-use networks, so that riders can complete the whole route without joining a road. Car-free routes also benefit many other walkers, wheelers and cyclists.
- Careful management of shared routes is essential to protect the safety of horse riders as well as other users.

Path surfaces

- Horse riding relies on a firm, well-drained, non-slip surface which is to a large extent compatible with the requirements of other accessibility needs. The surface should be smooth and without larger loose and angular stones. However, more unforgiving materials such as concrete and tarmac can be slippery for horses and can put a strain on their feet and legs over prolonged periods of use. See [Section A.6 Path surfaces](#) for more guidance on path surfaces.
- Single-use horse riding trails give the option of choosing surfaces that are best for this purpose, such as well-drained grass or woodchip. In some situations, an adjacent trotting strip could be considered along a shared-use route.
- Where space allows, dedicated equine strips can be the best solution for all users.
- Good maintenance is essential to keep surfaces clear of debris and coarse aggregate that can injure horse hooves.

Path widths

- The wider the width, the safer it will be for different path users thereby reducing potential conflict between them.
Aim for a width of 2–3m.
A width of at least 1.2m is required for a rider to walk along leading their horse, but this leaves no room for others to pass.
- Shared paths that are narrower than 2m should have passing places.
- Control of encroaching vegetation is important to retain the usable path width.
- The minimum height of a mounted rider is 2550mm above ground level. Paths should be kept clear of branches and other obstructions to a minimum of 3m, ideally 3.7m.

Equestrian gate widths

- 1525mm minimum clear width for gaps and gates.
- Latch design should ensure that the latch does not dig into the side of the horse or rider.
- Sufficient maneuvering space should be provided either side of bridle or field gates to allow users to operate a latch and to move through. Some horses and mobility vehicles need at least 3m diameter maneuvering space.
- More guidance on accessible gate design for horses at www.bhs.org.uk/advice-and-information/free-leaflets-and-advice



Examples of good practice

Pony Axe S is based in Glasgow and offers horse-drawn rides across all types of landscape, from beaches to moorland. The vehicle has space for a wheelchair and provides an innovative means of access. <https://ponyaxes.com/>



istock.com/Phynart Studio

The therapeutic benefits of horse riding are widely recognised and there are many programmes throughout the UK that offer social and therapeutic riding.



Further guidance

Equestrian Access Factsheets, British Horse Society Scotland, Scottish Natural Heritage and Paths for All www.outdooraccess-scotland.scot/doc/british-horse-society-equestrian-access-factsheets

British Horse Society Access work www.bhs.org.uk/about-us/access/

Path Bridges Guide, Paths for All <https://www.pathsforall.org.uk/resource/path-bridges>

A.14 Assistance dogs

Over 7,000 disabled people in the UK rely on an assistance dog to help them with daily tasks and to support independence and confidence. This includes people who are blind and partially sighted, D/deaf and hard of hearing or autistic and people with medical conditions such as epilepsy and diabetes.

Assistance dogs are highly trained which means they will stay close to their owner and are unlikely to stray or foul in a public place. They may be trained by an accredited organisation or by the owner.

Legal responsibilities

It is important that staff are fully aware of the law, so they avoid putting unnecessary barriers in the way of disabled people, for example by challenging entry or asking to see 'evidence' that owners are not legally required to produce.

It is unlawful to refuse a service to a disabled person accompanied by an assistance dog except in the most exceptional circumstances. Assistance dogs may be recognisable by a harness or jacket, but the law does not require an owner to identify it in this way or to carry ID or accreditation documents that provide information about the dog's training.



What does inclusive practice look like?

- ▶ Assistance dogs are welcomed and supported and this is reflected through staff and volunteer attitudes and aspects such as providing water and toileting areas.
- ▶ Staff are aware of the different types of assistance dog and the relevant aspects of the anti-discrimination legislation.



Design guidance

Welcoming assistance dogs

- If you have signs saying dogs are not allowed, show that this does not include assistance dogs.
- Ensure that staff and volunteers are aware that they must allow access to assistance dogs and that owners are not required to show ID or a particular dog coat or harness.



Examples of good practice



istock.com/Annette Birkenfield

There is growing awareness of the diversity of assistance dogs and the important role they play in supporting a wide range of people.



istock.com/Eileen Groome

Disabled dog owners need access to recreation space, toileting areas and dog waste bins.



Further guidance

Equality and Human Rights Commission, Assistance dogs: a guide for all businesses. www.equalityhumanrights.com/en/publication-download/assistance-dogs-guide-all-businesses

Assistance Dogs UK, Information for service providers www.assistancedogs.org.uk/the-law/

B. Guidance

Facilities and activities

.....

B.1 Seating and shelter

The importance of seating, shelter and shade is often underestimated but they are key to making a site or route accessible. Seats provide an opportunity to pause and rest as well as a chance to chat with friends, to actually be in a place rather than just passing through. Shade and shelter are becoming more important as climate change brings more intense weather.

It is important to ensure that these features are available for people who need them most. For some people with limited stamina, going out may not be possible if there are no opportunities to sit and rest. Seating is one of the simplest ways of improving access and can dramatically improve the experience for many people.

Interesting views, features and gathering points are typical locations for seating and shelter but it is important to consider where else they can be beneficial. Observing how people use a site or route, or undertaking surveys to invite feedback, can help you determine the best locations for seating and shelter. This might not always be the locations you would assume.



What does inclusive practice look like?

- ▶ There is plentiful seating, shelter and shade around a site or along a route.
- ▶ Seating is prioritised where it offers a rest from challenges like gradients, steps and long distances.
- ▶ A range of seating with different heights and styles enables people to find ones that best suit them.
- ▶ Seating, shelter and shade design provides space for wheelchair users, pushchairs and mobility scooters.



Design guidance

Location

- Prioritise seats as resting points at the top, bottom and level sections along ramps and steps and to break up long distances.
- Prioritise seating, shelter and shade in areas where people are likely to spend time, such as drop-off and pick-up points, viewpoints, play areas and somewhere to enjoy a chat or eat together.

- Locate seats at regular intervals, ideally no further apart than around 100m. In less intensively managed sites and routes it may be possible to make use of existing features such as boulders and fallen trunks.
- Where possible, aim to ensure that from each seat people can see the next one so they can pace themselves.
- Seats should be set back from the main route to allow the free passage of through traffic.
- Ensure that seating areas and their approaches have a firm, level surface.
- Open grass is a popular location for picnic tables, but grass is a challenging surface for manual wheelchair users and many ambulant disabled people. It is important to locate at least some tables where they can be reached across a more accessible surface.
- Ensure seats and shelters are as clear as possible to blind and partially sighted people, for example with good visual and tonal contrast, and not placed where they will create an unexpected hazard on a path.
- Include space alongside seats and as part of table design for people using wheelchairs, mobility vehicles or pushchairs. Allow a space of 900mm x 1400mm minimum, preferably 1200mm x 1400mm.

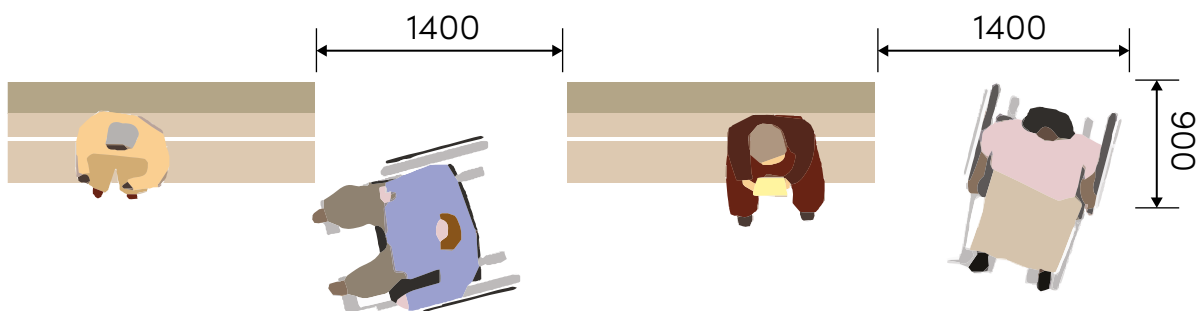

Seating style

- Provide a mixture of seating types to accommodate a range of ages and disabilities.
- Prioritise seats with backs and arms. Armrests can be used as leverage when standing up, and backrests provide important lumbar support.
- Perches are simple resting points that provide leaning or semi-seated rest. They are a useful addition to seating but should not be seen as a replacement. They are usually constructed from wood.
- Existing features can be used for seats or perches, for example low walls, fallen tree trunks, boulders and logs.
- Seat designs might also incorporate carvings, sculpture, location and distance information, or other site interpretation.

Dimensions

- Where possible, provide seats in a range of heights between 380mm and 480mm. 380mm is accessible for people of short stature; 480mm

is easier for people who find it difficult to stand up from a low seat and allows lateral transfer by wheelchair users.

- If only one seat type can be provided, aim for a seat height between 450mm and 480mm.
- The seat should be designed to prevent rainwater from collecting on it, for example by being sloped slightly.
- Perches should be 650-800mm high.
- Children may prefer seats as low as 350mm high.
- For a wall to be suitable as a perch, the top of the wall should have a depth of at least 300mm. An overhang of approximately 100mm makes it much easier for people to stand up and sit down.

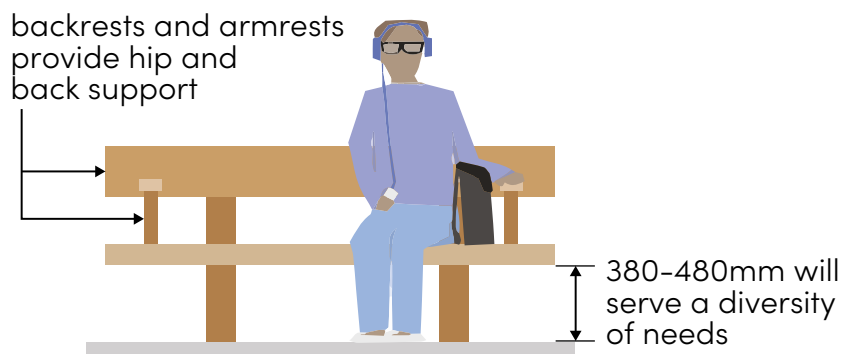

Maintenance

- Reduce or remove vegetation growth at viewing points to ensure that views are unobstructed, taking into account people's different viewing heights.
- Regular checks are essential to ensure seating remains structurally sound and in good repair.



Examples of good practice



iStock.com/Dean Hindmarch

Seats near a path, with space for wheelchairs, mobility scooters and pushchairs ensure that people can sit and enjoy the space together

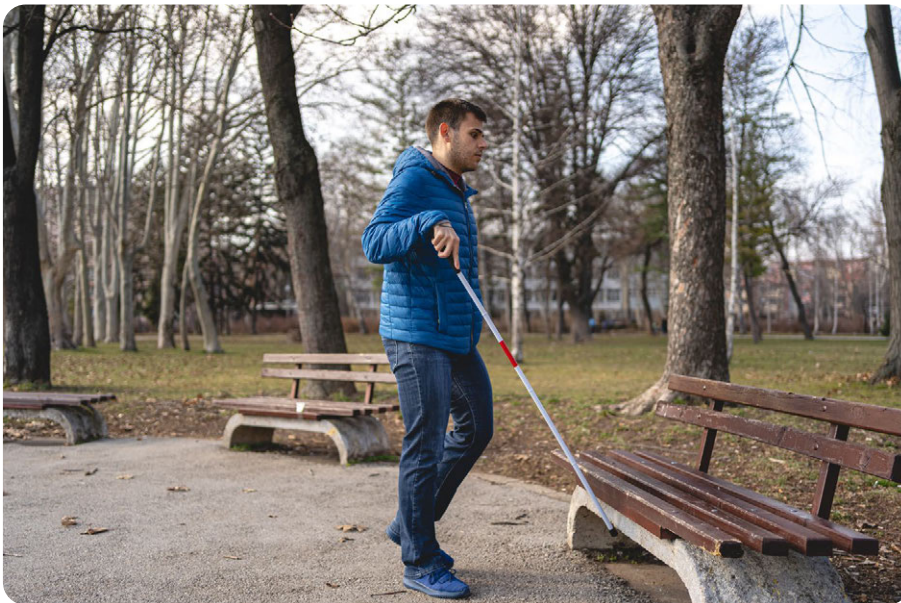

iStock.com/FluxFactory

Careful location of seating ensures that blind and partially sighted people find the seating easily and it doesn't cause an unexpected hazard or obstacle.



iStock.com/urbazon

Seating layout also impacts on how easy it is for people to sit and have a conversation using sign language.



Paths for All



Paths for All



Paths for All



Paths for All

These seats at Paths for All's demonstration site demonstrate the importance of details such as arm rests and accessible seating locations and angles.



Sensory Trust

Seating along the clay trails in Cornwall make the most of existing features, in this case boulders.



iStock.com/Richard Johnson

While incidental opportunities to sit shouldn't replace more inclusively designed seating, the use of existing features such as fallen trees can be a bonus for walkers.



iStock.com/Robert Pavsic

Tables with seating that isn't fixed and can be moved is more flexible for everyone. Comfortable table height ensures a wheelchair user can sit up to the table.



Julia Matthews/Forestry England

Timber structures provide shelter, seating and viewing points along the trails in Forestry England's Haldon Forest. Credit:



Further guidance

Sensory Trust guidance on seating and shelter www.sensorytrust.org.uk/resources/guidance/seating-and-shelter

Paths for All and NatureScot, Outdoor Access Design Guide www.pathsforall.org.uk/resource/outdoor-access-design-guide

Disability Sport Northern Ireland (2021) Accessible outdoor places guide. Section 2.2

www.dsni.co.uk/wp-content/uploads/2021/07/Guide-5-Accessible-Outdoor-Places-Design-Guidelines.pdf

Dementia friendly design, Paths for All

<https://www.pathsforall.org.uk/dementia-friendly-environments>

B.2 Toilets, showers and Changing Places

Accessible toilets are essential and a lack of toilets can prevent or limit a visit by many people including disabled people. Where it is not possible to provide them on a route or site it is helpful to highlight the nearest ones in the local area.

[Changing Places toilets](#) provide larger spaces with accessible toilets, showers, hoists and changing facilities to support visits by people with profound and multiple disabilities.

Showers are more likely to be provided in key recreation sites, especially where there are activities like cycling. Designing these facilities to be inclusive ensures that everyone can use them.



What does inclusive practice look like?

- ▶ Accessible toilets and changing facilities are available.
- ▶ On sites and routes without permanent toilets, nearby facilities are promoted.
- ▶ People can find out about accessible toilets in pre-visit and on-site visitor information.
- ▶ Accessible toilets are clearly signposted upon arrival and other key points of the site.



Design guidance

General considerations

Information about toilets should be provided in visitor information that people can use before or during a visit, enabling them to plan accordingly.

- On sites where permanent toilets are difficult to provide, it helps to publicise nearby facilities and to organise temporary measures for public events or at particular times of year. This could include signposting people to the [map of Changing Places toilets](#) across the UK.
- If the accessible toilets require a [resolve](#), supply this information, along with where to find this key, in the off-site information via a website or leaflet. Toilets should not be kept locked unless absolutely necessary.
- In larger or popular sites, Changing Places toilets should be provided in addition to accessible toilets. [Changing Places: the practical guide](#) provides comprehensive advice on the location, layout and signage of Changing Places toilets.
- If no utilities are present, consider solar power and long drop or self-composting toilets. Portable accessible toilets and Changing Places toilets are also available to hire.
- Gender-neutral toilets, also known as all-gender toilets, can be used by anyone but they are especially important for trans and non-binary

people who may feel unsafe or unable to use gendered facilities. Most accessible toilets are gender-neutral.

- Toilet design must comply with building regulations and standards and any other relevant standards.
- Details make a huge difference, for example ensuring good visual contrast between any fittings and walls and doors. Avoid small door lock indicators and door signs that are difficult to see.
- Staff and volunteer training is important to ensure there is an awareness of the many people with hidden disabilities who need to use accessible toilets. This minimises the risk of unwittingly discriminating against people with an access need.

Baby changing facilities

- Baby changing facilities should be accessible and located in a separate space to accessible toilets. This ensures that the toilets remain available for people who need them.
- Gender-neutral baby changing facilities are especially important for trans and non-binary parents and carers.
- Where baby changing has to be located in gender-specific toilet areas, it is important that they are provided in both female and male facilities. The tendency for them to be located in female toilets creates an access barrier for fathers and other male carers.
- A changing bench that can accommodate a small child, rather than only a baby, widens its use. This can be especially helpful for parents of children with additional needs.
- Refer to BS8300-2:2018 section 18.3 for more detailed information about the design of accessible baby changing facilities.

Location

- Prioritise accessible toilets near arrival and departure points, and key locations on site where people are likely to spend time (eg play area, cycle hire).
- Toilets should be served by accessible routes and involve a distance of less than 50m to get to and from key locations.

Layout, fittings and fixtures

- There is a tendency for toilets with adapted equipment to look overly clinical; careful choice of colours and materials can resolve this.
- Doors should open outwards to maximise internal space, sliding doors are acceptable if space is at a premium.
- Door width should be at least 1000mm.
- Handles and locks should be easy to use and with good visual contrast against their background. A common issue for people with partial sight is the small size of the lock display that shows if a toilet is in use or available. Larger ones are available.
- In countryside settings, generous spatial layouts of both accessible and standard toilets will allow for people carrying items such as raincoats

and rucksacks. Coat hooks in the toilet cubicle are a necessary feature for the same reason.

- Choose hand driers that are not overly noisy. Some models are excessively loud and can be distressing for many people.
- Ensure that fittings such as driers, paper towel dispensers and taps are easy to use and obvious in how they function. For example, some towel dispensers look like they could be driers and this can be confusing for people with dementia.
- Fittings such as toilet roll holders, dryers, mirrors and coat hooks should be positioned to be reachable from a wheelchair or standing and should consider people of short stature.

Signage

- Wayfinding signage should make it easy for people to find toilets.
- Toilet signs should be clear and easy to spot from a reasonable distance.
- Door signs should be large enough, and symbols clear enough, for people to know which toilet to use. Tiny door signs can be hard to see, and overly stylised symbols can be confusing. Symbols and text together are most helpful.



Examples of good practice

Examples of Changing Places facilities



A Changing Places facility at Ilam Park where the wall provides beauty as well as effective visual contrast for the white sanitary furnishings. Read more about the story of installing this facility: www.nationaltrust.org.uk/ilam-park-dovedale-and-the-white-peak/features/a-changing-place



A Changing Places facility installed by Suffolk Wildlife Trust at Carlton Marsh. Credit: Jo Leng

“These mean so much to families like ours, makes going out so much easier”.
“This is great, not enough places have these facilities”.

Toilet signage

Paths for All’s development of a dementia-friendly design in Kings Park, Stirling includes dementia-friendly toilet signage www.pathsforall.org.uk/news/news-post/scotlands-first-dementia-friendly-park-is-launched-in-stirling

Grace’s Sign is a new inclusive toilet door sign created by 12 year old Grace Warnock to raise awareness of the needs of people with hidden disabilities. The sign is in use on toilet doors across Scotland including the Scottish Parliament. www.pointsoflight.gov.uk/graces-sign/



Further guidance

BS 8300-2:2018: Toilets and Changing Places. www.shop.bsigroup.com/products/design-of-an-accessible-and-inclusive-built-environment-external-environment-code-of-practice/standard

Inclusive mobility: A guide to best practice on access to pedestrians and transport infrastructure Department for Transport, 2021 www.gov.uk/government/publications/inclusive-mobility-making-transport-accessible-for-passengers-and-pedestrians

Disability Sport Northern Ireland (2021) Accessible Toilets, Changing and Showering. Section 2.5 www.dsni.co.uk/wp-content/uploads/2021/07/Guide-5-Accessible-Outdoor-Places-Design-Guidelines.pdf

B.3 Car and cycle parking

Access to car parking and drop-off within easy reach of a destination is a key requirement as many disabled people, older people and families with young children rely on vehicles to travel. This includes cars, wheelchair accessible vehicles (WAVS), taxis and group transport like minibuses arriving as both drivers and passengers. It is important to note the increasing use of larger vehicles and trailers for carrying mobility equipment such as scooters and adaptive bikes.

Car parks are sometimes destinations in their own right, especially when they have good views and accessible facilities. They can provide the opportunity to be in the countryside or by the coast even if people can't explore much beyond the vehicle.



What does inclusive practice look like?

- ▶ Designated accessible parking provision responds to any requirements set by building regulations or standards.
- ▶ Accessible car and cycle parking as well as drop-off areas are clearly identified and located close to key destinations.
- ▶ Vehicle and cycle parking serves the diversity of potential uses, including large vehicles and adaptive bikes.
- ▶ Parking areas are well linked by accessible routes to destinations.
- ▶ Electric charging points are accessible to mobility vehicles and electric vehicles.



Design guidance

General considerations

- Pedestrian routes through and beyond the car park should be level, free of loose materials and with a maximum crossfall of 1:50 (2%). They should ensure easy access from the car spaces to destinations and facilities like ticket machines and seating.
- Seating adds important accessibility, providing rest for people waiting to be picked up, or giving people a chance to sit outside their car and enjoy a view even if they can't venture further.
- If parking cannot be provided on site, it is helpful for visitor information to share details of the nearest accessible public parking.
- Associated facilities such as electric charging points, ticket machines and waste bins should be accessible, with particular attention paid to reachable heights and accessible routes.
- There should be clear, accessible information that visitors can use to work out their journeys onwards from the car park. This should highlight

essential features such as toilets, route options and information about the accessibility of different routes.

Location

- Accessible parking, drop-off and pick-up should be close to entrances, destination points and gathering spaces. The parking should be ideally no further than 50m, and drop-off points closer if possible.
- Where possible, also provide accessible parking in locations where people can enjoy a view or a particular area without having to venture far from the vehicle.
- If parking opportunities are limited, priority should be given to designated spaces and opportunities for drop-off.
- Parking provision should accommodate large vehicles, minibuses and trailers. These are often used to transport mobility scooters and adaptive bikes. A group with access needs may rely on a minibus. Horse riders may arrive at a site with a horse transport vehicle.
- Cycle parks should take into account adaptive bikes, including tricycles. Bicycle parking might be closer to an attraction than car parking, increasing the incentive to cycle. Bicycle parking should be as dry and secure as possible.
- The Blue Badge scheme allows disabled people (who meet the assessment criteria) to park closer to their destination, either as the driver or passenger. It includes people with hidden disabilities, and it is important that staff and volunteers understand not to make assumptions about individual access needs.
- Not all disabled people are Blue Badge holders, and it is important to make all parking provisions as accessible as possible.

Signage and approaches

- Accessible parking should be clearly identified from the main approaches, noting that people may need this information when they arrive in their vehicle, or as pedestrians when returning from a route or site.
- Routes from the car park should be clear so that people can easily find their way.
- If there are multiple car parks and drop-off points, provide consistent maps and signage so people can orientate themselves. It will also help them to remember where they parked after a visit.
- Accessible parking bays should be clearly marked so they are obvious to people who need them and to reduce the risk of misuse by others. This includes ground markings and adjacent signs. The wheelchair symbol is widely used to indicate the designation.
- Accessible parking designated for staff or volunteers should be clearly differentiated from spaces that are available for public use.
- Height barriers should be avoided to allow for taller vehicles.

- Safety of pedestrians in parking areas is paramount and the aim should be to separate pedestrian and vehicular movements as much as possible.
- Accessible parking should be on a firm, level surface with a gradient of less than 1:50 (2%).
- Dropped kerbs must be provided for wheelchair users. They should have a maximum gradient of 1:12 (8%) and a preferred maximum of 1:20 (5%). They should be positioned to provide convenient routes through the parking area and beyond.

Parking bays

- Accessible parking bays should be wide enough for car doors to open fully either side and to the rear. They should take into account the larger size of many modern vehicles.
- Refer to current building regulations and standards for bay dimensions. The provision of some wider or enlarged standard bays (6m long, 3.6m wide) will help future-proof the need for additional designated spaces and will be helpful for people who need more room getting in and out of their vehicle.
- Aim to provide at least one larger space (4.8m x 8m) for vans and minibuses with side and rear hoists commonly referred to as wheelchair accessible vehicles (WAVs), lifts, and trailer towing mobility vehicles.

Number of designated spaces

- The number of designated parking spaces will depend on the type of site or route, its activities and patterns of use.
- General recommendations are:
 - Provide one space for each employee or volunteer who is a disabled motorist.
 - Provide at least two designated visitor spaces for smaller car parks (less than 40 cars).
 - Provide at least 6% accessible spaces for larger car parks (over 40 cars).
- A site that has a particular focus on accessible outdoor activities should provide a higher proportion of accessible parking.
- It is important to reflect any prescribed ratios set by building regulations and standards.

Ticket machines

- Ticket machines should be clearly signed and located closest to the accessible parking spaces.
- Machines should clearly indicate any pricing concessions.
- Machines should be sited where they are easy to get to by people using wheelchairs or mobility scooters.

- Clear space in front of machines should take account of wheelchair and scooter dimensions, ideally allowing at least 900mm x 1800mm, more if allowing for turning space. See Section A.4.
- Recommended height of controls: 750mm-1200mm above ground level.
- Displays should be easy to read with good visual clarity and contrast, and simple to use.
- Plinths should not extend out so far that they impede access for wheelchairs or scooters or cause an obstacle for people who are blind and partially sighted.



Further guidance

BS 8300-1:2018: 7 Parking provision.

www.shop.bsigroup.com/products/design-of-an-accessible-and-inclusive-built-environment-external-environment-code-of-practice/standard

Disability Sport Northern Ireland (2021) Accessible outdoor places guide. Section 1.1

www.dsni.co.uk/wp-content/uploads/2021/07/Guide-5-Accessible-Outdoor-Places-Design-Guidelines.pdf

B.4 Planning inclusive activities and events

An inclusive approach to planning and managing activities and events is one of the most important ways of widening access and participation. This can include improving access to existing activities as well as diversifying the range of opportunities on offer.

Some outdoor spaces run full programmes of events throughout the year, ranging from nature days to live music. An increasing number of sites are offering facilities that people can hire for barbecues, birthday parties and weddings.

It is essential to understand what activities and events people would like to see, therefore community engagement is valuable. This should prioritise communities who have limited engagement with the site or route.



What does inclusive practice look like?

- ▶ Activities and events attract and support a wide diversity of participants, both as visitors and presenters or facilitators.
- ▶ Activities and events are successful, feedback is positive and people are keen to attend more.
- ▶ New community relationships are built because a wider range of people are engaging with your organisation, site or route.



Design guidance

Planning events

- Ensure that your venue is easy to get to and accessible to get around so that it will support people with a variety of access needs.
- Include subsidised and free places for people in relative low income.
- When considering numbers, think about the space that people will need. Circulation space should allow easy movement for wheelchairs, scooters, and assistance animals.
- Ensure that everyone involved in running the event is familiar with your inclusive working practices. Make sure you consider people giving presentations and external contractors.
- Consider lighting and acoustic levels, this is especially important for people who are D/deaf and hard of hearing and people who are blind and partially sighted. Ambient noise can be a significant issue.
- Remember to consider the accessibility of temporary facilities such as parking, toilets and track surfaces.
- Anticipate inclement weather conditions. Plan for the potential impact on access and identify options to use alternative routes and sheltered locations.

Promotion and communications

- Apply inclusive design principles to any communication materials (see Section C).
- Promote widely through website and social media channels, posters, flyers and sharing with local networks who can connect with a wide diversity of people.
- Give plenty of time for people to make arrangements for travel, accommodation and any other logistics. Parents and carers may need to arrange cover for example.
- Invite people to inform you of any specific access requirements.
- Provide clear information about how to get to the event including details about accessible transport, drop-off and arrival.

Event management

- Ensure easy access to any areas that will be used as part of the event, including both areas for participants and presenters or facilitators.
- Clearly sign the locations of accessible car parks, drop-off, on-site transport, accessible toilets, accessible routes etc.
- Ensure staff are made aware of accessibility aspects and know who to contact in case of issues that may arise.
- Choose practical activities that are inclusive so that everyone can participate.
- Develop risk assessments that consider diverse needs.
- Ensure that emergency evacuation procedures take good account of people with sensory and mobility disabilities.
- Allow additional time for moving between different locations and consider assisted transport if there are significant distances involved.

Vision and sound

- Consider clear visual sightlines for lipreading or sign language interpreters.
- Good lighting and acoustics are important for everyone, especially for people who are D/deaf and hard of hearing or blind and partially sighted.
- Check to make sure that hearing systems are in situ and functional. Alternatively, ensure portable induction loops are available.
- Autistic people and people with sensory processing issues can experience sensory overload from different sounds, visuals and other information happening at the same time. Try to create a calming environment and provide a quiet space that people can retreat to if they need time out.
- If you anticipate that the event could be particularly noisy, it is good practice to make available some ear defenders on request.

- Ensure that presenters are aware of the importance of describing any visuals for the benefit of people who are blind and partially sighted.
- If sign language interpreters are requested, ensure that they are given information about the event in advance including any PowerPoint slides or notes that can help them prepare.

Seating, eating and shelter

- If the event involves people standing, for example to listen to a talk, make sure seating is available for people who need it.
- When arranging tables and chairs, provide adequate space for wheelchair and scooter users and people with assistance animals to navigate between and to join tables.
- If the event is in the open air, include options for shade from the sun and shelter from the wind and rain.
- Ensure that food and drink accommodate food sensitivities, allergies, preferences and intolerances.



Further guidance

VisitScotland, Inclusive and Accessible Events: a guide for event organisers
www.visitscotland.org/binaries/content/assets/dot-org/pdf/marketing-materials/accessible-events.pdf

Equality and Human Rights Commission, Engaging with Disabled People: an event planning guide
www.equalityhumanrights.com/sites/default/files/housing-and-disabled-people-engaging-with-disabled-people-event-planning-guide.pdf

National Autistic Society's 'Too much information' campaign raises awareness of sensory overload and needing extra time to process information:
www.autism.org.uk/what-we-do/campaign/public-understanding/too-much-information

B.5 Children's play

All children benefit from being outside, interacting with their environment, learning from nature and developing through play. These experiences can be especially beneficial for children with disabilities and inclusive play makes these opportunities available to all children, regardless of ability and background. Inclusive play doesn't mean that every element is accessible to everyone, but it does mean that the combination of experiences adds up to something equally great for each child. Some children can't climb to the top of a rope, some don't want to and others really need to.



What does inclusive practice look like?

- ▶ Diverse and flexible play opportunities are available so all children can choose what best suits them.
- ▶ A multi-sensory design approach benefits all children, especially children with additional needs.
- ▶ Disabled and non-disabled friends and siblings can play together.
- ▶ Play includes creative, quieter activities, not just physically active options.
- ▶ There is seating and shelter nearby for parents and families.
- ▶ There is good access to play facilities, considering children and parents with disabilities.



Design guidance

General considerations

- Play by its very nature is diverse. Aim to include options to be physical, noisy and challenging, but also quiet, creative and reflective. Some children love the social aspect, while others need space that is quieter, with less sensory stimuli and where they can think more clearly without the noise of other children.
- Some children want to charge about and others are happier quietly playing in a sand pit. Some will be more prone to injury from others knocking into them.
- All health and safety criteria must be adhered to.

Location and types of space

- Children must be able to get to the play area from their home or car park so consider the door-to-door journey and not just simply the space.
- Within the play area, aim for a surface that has good impact absorption but is relatively firm (avoiding deep loose materials such as gravel).
- Make spaces where children have a choice of busier active areas and quieter areas. With physical play, choose a range of physical options,

perhaps some focused on upper or lower body and some that use motor skills for example.

- Consider widths, heights and reach for a diversity of children and integrate accessible play opportunities.
- Consider accessible information, signage and wayfinding, for example include tactile symbols, braille and pictorial images, as appropriate.
- Consider boundaries to define different spaces, reduce the scope for children to wander and protect children while they play.
- Include seating and shelter from inclement weather and strong sun.

Types of play

- Physical play: eg open space for running or wheeling, trees or logs for climbing and balancing; a wall for ball games; markings for chalk games; play equipment for different physical challenges.
- Quiet and reflective play: children with a sensory processing disorder can be very sensitive to noise and a calming space is beneficial for children generally.
- Creative play: eg spaces with natural materials for making things; weeping trees and sensory areas for dens; storytelling space.
- Social play: eg areas for chatting and reading, games such as outdoor chessboards and open spaces for group activities.

Engage the senses

- All children benefit from an approach that engages all the senses so aim to maximise opportunities.
- Choose materials and activities to explore through all the senses such as interesting textures, shapes, weights, patterns, colours and temperature.
- Heighten sensory stimuli in some areas and reduce it in others to provide choice.
- Consider children with sensory disabilities, eg things to explore through touch, sound, reflected light or strong colours and contrast.
- Simple carvings made from logs and natural materials can provide cheap and simple tactile interest.

Don't forget parents and families

- Make sure there is seating and shelter nearby for parents, grandparents and carers that permits easy observation of the play area.
- Parents, grandparents and carers may be disabled so ensure they can quickly access the play area from where they are sitting enabling them to support their children.
- Ensure disabled and non-disabled children can play together.

Learn and share

- Engaging with children and families before and after you design something is a tried and tested way of finding out what children

want and how successful your design is. Measuring effectiveness and evaluation should be a continuous process and not a one-off exercise.

- Research examples of inclusive play areas making sure that you share your experience with others as they share with you.



Examples of good practice



iStock.com/Sol Stock Ltd

Some play equipment is designed to be accessible to disabled children and can be integrated in an inclusive play area. All equipment can be made more accessible by considering how easy it is to get to, what elements can be reached and the widths of entrances.



iStock.com/Mikanaka

Remembering accessibility for disabled parents too.



iStock.com/StockPlanets

Opening up access to games areas ensures that everyone can engage in other types of play such as ball games.

Catherine Street Inclusive Play Park in Dumfries has been developed by the charity Include Us, to enable all children and young people to play together, regardless of ability. It has been developed by volunteer parents and local people and the park includes a diversity of creative play opportunities. www.includeus.org.uk/all-about-the-park/

Cannon Hall country park made a new adventure playground more accessible by looking at designs of equipment and how they could be adapted to make them accessible. This encouraged children of all abilities to interact and play together. www.cannon-hall.com/accessibility

Saughton Park and Gardens, Edinburgh has a play area that has been designed for young people of all ages and abilities. www.edinburghwithkids.com/saughton-park-and-gardens/



Further guidance

Design, manufacture and installation of play areas is a specialist field. Local authorities may be able to advise on reputable manufacturers and industry exemplars. More play manufacturers have inclusive play equipment but this tends to have a focus on children who use wheelchairs and less on wider disabilities. Find more information about UK suppliers from the Association of Play Industries: www.pi-play.org

Play Scotland, inclusive play design www.playscotland.org/inclusive-play-design/

Sensory Trust, guide to inclusive play www.sensorytrust.org.uk/resources/guidance/inclusive-play

Children's Play Policy Forum, a collective voice for children's play.
www.childrensplaypolicyforum.wordpress.com/

B.6 Picnic areas

Sharing food together is an important part of enjoying the outdoors, from a quick snack stop to a more organised group get-together. These opportunities are often supported by picnic tables, seating, bins and barbecues. Operational factors such as hours of opening and proximity to toilets and car parks, will influence who can comfortably use them.

Enjoyment of these simple pleasures is often limited by some consistent barriers to access. For example, picnic tables with fixed benches that are difficult to climb into and exclude wheelchair users; tables that don't allow for more than one wheelchair or scooter user to sit together; and tables placed in inaccessible locations, such as across rough grass, or where people feel unsafe.

Simple inclusive design considerations can make all the difference in opening up these opportunities for everyone.



What does inclusive practice look like?

- ▶ The most accessible facilities are within easy reach of accessible routes, car parks and toilets.
- ▶ Furniture such as tables and barbecues is accessible and provided in a range of styles and dimensions so they suit different needs.
- ▶ Facilities are available at flexible times of the day to suit the needs of both the local community and visitors.
- ▶ There are furniture and cooking facilities to suit larger groups as well as individual and small group use.



Design guidance

General considerations

- Most people find accessible picnic tables more usable, so where there is a mix of table styles the accessible ones are often taken up more quickly and not necessarily by people who most need them. The best approach is to provide more accessible furniture designs for use by everyone from the outset.

Location and layout

- Aim to locate picnic and cooking facilities where they can be reached via surfaces that are firm, even and without barriers such as loose materials, steps and steep gradients.
- Locate at least some picnic tables in places that have shade.
- Consider the proximity of facilities such as toilets, cafes and car parks, as well as the accessibility of associated features such as seating and bins.
- Consider people who want to share food in larger gatherings, as well as in small groups of friends or family.

Tables

- Table surfaces should range in height from 750–810mm.
- Table legs can obstruct chairs and wheelchairs and their position should be carefully considered.
- Wheelchair users need a minimum thigh clearance of 670mm between the ground level and the underside of the table.
- Some standard picnic tables have fixed bench seats either side that have to be climbed over to sit on. They are awkward for many people and impossible for some, and step-free alternatives should be sought.
- Tables should have room for more than one wheelchair user to share together. An increasing range of accessible picnic table designs provide multiple spaces for wheelchair users and seats accessed from the side.

See Section B.1 for more details about seating and shelter.

Barbecues

- Barbecues should be at a usable height (typically 860mm) and with unimpeded level access.
- Ensure sufficient clearance for wheelchair and scooter users to move safely around barbecues.



Examples of good practice



istock.com/Adam Kazmierski

Picnic tables with benches that can be accessed from the side are preferable to ones that people have to climb over. However, they still limit wheelchair access to each end (and in this case the hard surface has not been extended to include them).



Sensory Trust

This table design offers a more sociable mix of wheelchair spaces and seating. It is let down by the lack of easy access route to reach it.

BCP (Bournemouth, Christchurch and Poole) Council provides accessible electric barbecues at some beaches. Visitor information highlights the locations and accessibility of the facilities and there is an app that people can use to check how busy the beaches are. www.bpcouncil.gov.uk/Leisure-culture-and-local-heritage/Beaches-and-quays/Electric-beach-barbecues.aspx



Further guidance

Disability Sport Northern Ireland (2021) Accessible outdoor places guide. Shelters and picnic tables. Section 2.3

www.dsni.co.uk/wp-content/uploads/2021/07/Guide-5-Accessible-Outdoor-Places-Design-Guidelines.pdf

Paths for All – Outdoor Access Design Guide, perches, tables and picnic benches section 10, page 114

www.pathsforall.org.uk/mediaLibrary/other/english/outdoor-access-design-guide.pdf

B.7 Bins, temporary signs and furnishings

These items can seem incidental and often aren't included in access guidance but they can create real challenges for people. Three common issues arise: one is when they are placed at heights or in locations that disabled visitors find difficult to reach; a second is when they impede access or create hazards by being placed inappropriately; a third is when signs fail to reflect inclusive design practices, for example using smaller fonts or failing to include access information.

The most important solution is to ensure that these furnishings are included in the same design process as other features and fittings.



What does inclusive practice look like?

- ▶ Facilities are clearly marked, following principles of inclusive information, so they can be easily identified and are more likely to be used as intended.
- ▶ Temporary signs are located where they are least likely to cause a barrier or potential hazard, including to blind and partially sighted people.
- ▶ Temporary information is designed to the same standards of inclusive design as permanent materials.
- ▶ Bins, ticket machines and other furnishings are easy to reach and use.



Design guidance

- Ensure there is an accessible route and sufficient clear space on the approach to features such as bins and ticket machines.
- Pay careful attention to reachable heights (see Section A.4).
- Place dog waste and litter bins, or dual waste bins, in accessible locations and at reachable heights for all visitors, including wheelchair users.
- Ensure toileting areas for assistance dogs are clearly identified and accessible.
- Ensure that temporary information follows the principles of inclusive design and includes any relevant information about access. For example, temporary signs that indicate a closed-off route should show which other routes are accessible.

B.8 Health walks

The health and social benefits of walking are now well recognised and there are numerous initiatives across the UK designed to encourage more people to participate. Healthy or health walks are usually aimed at people who are most likely to benefit from being more physically active. There are significant mental health benefits that come from the social aspects of walking. For example, people who are recovering from ill health or managing a long-term health condition.

Walk programmes often involve collaboration between community groups and organisations and the owners or managers of outdoor sites and routes. Some programmes also engage GPs, health professionals and social prescribers who provide a connection between health care and social action.



What does inclusive practice look like?

- ▶ Health walks are inclusive, so they are available to the widest range of participants.
- ▶ Walks are successful, feedback is positive, and people are keen to continue to attend.
- ▶ New community relationships arise that can provide informal support networks.



Design Guidance

Making plans

- Choose accessible routes and meeting venues.
- When considering numbers, think about the space that people will need. Circulation and manoeuvring space should allow easy movement for wheelchairs, scooters, and assistance animals.
- Ensure that anyone involved in running the walks is familiar with your inclusive working practices. Volunteers must be trained.
- Develop safeguarding and risk assessment procedures that take account of diverse needs. These should identify clear policies for what to do if issues arise, and support and advice for volunteers and staff running the activities.
- Develop good working relationships with community transport and health providers, as appropriate, who may become important delivery partners.

Promotion and communications

- Apply inclusive design principles to any communication materials (see Section C).

- Promote through diverse channels including online (website, email, social media), direct through posters and flyers, and through local networks to share with a wide diversity of people.
- Local health providers and networks may be a valuable means of sharing information and encouraging people to join.
- Give plenty of time for people to make arrangements for travel and any other logistics. Parents and carers may need to arrange cover for example.
- Invite people to get in touch if they have any specific access requirements.
- Provide clear information about how to get to the walk including details about accessible transport, drop-off and arrival.



Examples of good practice



Paths for All

Buggy walks are a great way for expectant or new parents to get active while caring for their baby www.pathsforall.org.uk/walking-for-health/buggy-walks



Paths for All

Dementia friendly walking www.pathsforall.org.uk/dementia-friendly-projects



Sensory Trust

Choosing locations that offer plenty of opportunity for sensory exploration as part of walking and activity groups.



Sensory Trust

An important reminder that providing opportunities for adults to have fun outdoors is important too. Dementia walking group, Sensory Trust.

Walking groups

The following are examples of initiatives around the UK that diversify opportunities for people to engage in community walking and bring physical and mental health benefits.

Walking and activity groups for people living with dementia, Sensory Trust www.sensorytrust.org.uk/projects/dementia/activity-groups

Walking group for people who are blind and partially sighted, Paths for All www.pathsforall.org.uk/walking-for-health/wfh-success-stories/wfh-story/A-walking-group-for-people-with-visual-impairments-wins-our-Volunteer-Diversity-Award

Walks and rambles with disabled people, families and friends in north of England www.experiencecommunity.co.uk/walks/

Welcome walking group for people who are blind and partially sighted, RNIB www.pathsforall.org.uk/walking-for-health/wfh-success-stories/wfh-story/new-walk-is-finding-its-feet

Health walks offering people-centred community support www.pathsforall.org.uk/walking-for-health/wfh-success-stories/wfh-story/health-walks-offer-people-centered-community-support

Walking for people with severe mental health conditions, NHS Forest www.nhsforest.org/projects/green-walking-in-mental-health-recovery/

Hiking and adventure group for Muslim women www.thewanderlustwomen.co.uk/

A safe place for Black women to explore the outdoors www.bghuk.com/

Encouraging greater activity outdoors

A series of short YouTube videos created by deafscotland using BSL provide tips to encourage D/deaf people to be more active outdoors www.alliance-scotland.org.uk/

Step It Up! 7 Tips to get you walking! www.youtu.be/kKCanXY65Mo

Walking and Talking Tips www.youtu.be/-UCpOLq-KtY

Social Communication Tips www.youtu.be/C-si4P6Cty0

Paths for All 'walk agreement cards' are translated into ten different languages www.pathsforall.org.uk/news/news-post/health-walk-agreement-now-available-in-10-languages



Further guidance

Paths for All's Health Walk model www.pathsforall.org.uk/walking-for-health

Sensory Trust dementia walking and activity programme
www.sensorytrust.org.uk/projects/dementia/activity-groups

Walking for health resources, Public Health Agency Northern Ireland Walking for Health resources (leaflet, poster, certificate etc) | HSC Public Health Agency
www.hscni.net

B.9 Beach activities

Beaches are typically some of the least accessible locations, with barriers ranging from the soft sand and pebbles of beaches themselves to the distances, steep slopes and steps that people have to negotiate to reach them. Beaches, and associated activities like swimming and surfing, have not received so much attention in terms of accessibility but fortunately this is changing. There is a growing number of examples where permanent and temporary access improvements are opening up beaches so that people of all ages and abilities can enjoy them.



What does inclusive practice look like?

- ▶ There is reliable public information about the accessibility of beaches, activities and transport options.
- ▶ There is equipment available for hire, such as beach wheelchairs, and inclusive activities such as boating and surfing.
- ▶ The beach has accessible parking and drop-off, places to sit and accessible routes to the water.



Design guidance

Access to beaches

- Provide accessible parking and drop-off nearby.
- Provide seating and areas to shelter from the sun and wind that can be reached by accessible routes.
- Develop an accessible route from the parking area following the guidance in Section A.1.
- Clearly identify accessible routes and facilities on signage, maps and information.
- Portable mats can be rolled out to create routes as and when needed. These are seen throughout Europe and in the USA and are now starting to be used in the UK. They are valuable for enabling access to the water or specific area from a beach walkway. Examples include MobiMat www.accessrec.com/beach-access-mat

Beach boardwalk

- Follow the guidance provided in Section A.11.
- Note that walkways can be especially busy in some beach areas and the wider widths will be necessary to ensure safe and easy two-way use. In addition, beach boardwalks are especially susceptible to wear and tear and will require frequent inspections and maintenance.

Beach facilities and activities

- Provide accessible toilets and changing facilities, ideally including a Changing Places toilet.
- Ensure that at least one beach hut is wheelchair accessible. If developing new ones, ensure they all follow principles of inclusive design so that any can be used by wheelchair and scooter users.
- Encourage shops and cafes to adopt inclusive practices so that these facilities add to the overall accessibility of the beach experience.

Beach equipment

- Beach wheelchairs have large wheels that support easy movement across sand and shallow water. Floating chairs have buoyancy aids to support activity in the water.
- Adapted surfboards have been created by Surfability UK to support people who have additional needs due to disability, illness, injury or learning difficulties.

Maintenance

- Regular maintenance is essential to ensure that permanent walkways remain in good repair.



Examples of good practice



Emma Muldoon/Simply Emma

Emma Muldoon of 'Simply Emma' an accessible travel, disability and lifestyle blog. A brilliant resource and a great place to see beach wheelchairs in action along with examples of accessible beaches. www.simplyemma.co.uk/?s=beach

Examples of improved access to beaches

The Mae Murray Foundation in Northern Ireland is working on the development of inclusive beaches, including technical issues and management of an inclusive beach environment:

www.maemurrayfoundation.org/projects/inclusive-beaches/

Sandbanks beach, Poole is one of the first places in the UK to pilot a MobiMat (portable mat) and beach wheelchairs. www.disability-grants.org/sandbanks-shore-road-branksome-chine-beaches-poole.html

Bournemouth beaches include cliff lifts, land train, and accessible beach huts www.bcpCouncil.gov.uk/Leisure-culture-and-local-heritage/Beaches-and-quays/Accessible-seafront.aspx

Portobello beach, Scotland is a great example of different types of beach wheelchairs. www.beachwheelchairs.org/portobello

St Andrews beach wheelchairs increase access to the beaches in and around St Andrews. Developments include a new boardwalk and a Changing Places facility. www.standrewsenvironmental.org/projects/st-andrews-beach-wheelchairs

Sea the Change promote sustainability, education and accessibility and have created a beach wheelchair project at Coldingham Bay www.seathechange.org.uk/beach-wheelchairs

Rainbow beach, Alanya, Turkey shows an exciting new development, where an 'autonomous lift' or 'sea elevator' has been installed, which allows disabled people to enter the sea without having to receive support from anyone www.accessibletourism.org/?i=enat.en.news.2149

Barcelona beaches have developed an accessibility model to make it easier for disabled beachgoers to enjoy the beaches. It highlights parking, accessible paths, boardwalks, beach wheelchairs, volunteer assistance, showers and toilets. www.barcelona.cat/en/what-to-do-in-bcn/bathing-and-beaches/accessibility



Further guidance

Disability Sports Northern Ireland, Accessible outdoor places guide, page 163: www.dsni.co.uk/wp-content/uploads/2021/07/Guide-5-Accessible-Outdoor-Places-Design-Guidelines.pdf

A personal perspective on the best wheelchair accessible beaches UK www.simplyemma.co.uk/best-wheelchair-accessible-beaches-in-the-uk/

Inclusive surfing organisation based in Wales www.surfabilityukcic.org/

B.10 Birdwatching

Birdwatching is a popular pastime in the UK and many people enjoy it as part of spending time outdoors. Supporting casual opportunities for spotting birds is as important as providing dedicated facilities. People who are blind or partially sighted may engage more with the sounds of birds, while for people who are D/deaf and hard of hearing the visual aspects will be especially important.

Birdwatching has tended to be most popular amongst older people and while this continues, there is growing interest amongst younger people and a wider range of ethnic and cultural backgrounds. There are reports of many more people developing an interest in birdwatching as a result of the Covid-19 pandemic.



What does inclusive practice look like?

- ▶ Accessible seating has been created in quiet locations to support birdwatching.
- ▶ Inclusive birdwatching activities are promoted and supported.
- ▶ There is accessible information to share insights about birds.
- ▶ Bird hides and viewing points are accessible and clearly identified in the visitor information and on site.
- ▶ Individuals and groups representing diverse communities inspire and support a wider diversity of people to engage.



Design guidance

General considerations

- Access to birdwatching in its simplest form relies on good general accessibility as well as the provision of sitting spots where people can spend time being quiet and encouraging more birds to appear. Inclusive interpretation and education techniques can inspire people to take more notice of the birds they are likely to encounter.
- If birdwatching is a primary focus of your site, there may be scope to support this interest through infrastructure such as accessible bird hides, feeding stations and guided activities.
- Events, like murmurations or the arrival of a particular migrating bird, can provide really memorable experiences. Access improvements may include providing accessible parking in key locations, along with good information on site. Organising events designed to support people who may not feel confident about taking part can be a good way of sparking new interests and widening the opportunities to people who wouldn't normally be able to participate.

Location

- Aim to provide seating opportunities for people to enjoy bird life from the most accessible routes, as well as in more remote and harder-to-reach parts of a site.
- Prioritise designated parking for disabled people in locations with the best views.
- Aim for at least some bird hides to be within easy reach of parking, perhaps by providing some designated accessible spaces in locations nearer bird hides.

Communication

- Promote inclusive opportunities to join in with birdwatching activities, or to visit places that are accessible and rich in birdwatching opportunities.
- Birdwatching guides often have small text and illustrations and are quite complex to use. Aim to provide simple, clear information with larger text and images to make it more widely accessible.
- Tactile images of birds can help blind and partially sighted birders connect the physical qualities of the birds with the sounds they hear.
- Visual communication will be important for D/deaf and hard of hearing birders and this could include visual representations as well as apps.
- Simple videos are effective at sharing information about accessibility and inspiring people to join in. This is a nice example from Birdability in the US www.birdability.org/watch-and-listen

Bird hide access

- Ideally all bird hides should be fully accessible. If this is not possible then the fully accessible hides should be clearly identified through signs, maps and information.
- A level platform outside the door 2000mm x 2000mm provides room for wheelchair and scooter users to open the door and passing space for people arriving and leaving.
- A hide should have a step-free approach and entrance. As most hides are constructed above ground level this may need a ramp (see Section A.7). The entrance should be wide enough for a wheelchair user or mobility scooter (minimum 1000mm).
- Interior space should be free of obstacles with sufficient manoeuvring space for wheelchairs. Larger mobility scooters can require at least 2800mm x 2200mm.
- Doors should slide open or open outwards to maximise space inside and should be easy to open and close.
- Thresholds across the base of the door should be wheelchair accessible.
- Bench space should include removable or liftable sections to enable viewing from a wheelchair or mobility vehicle, with knee space so visitors

can get close enough to view. Some seats should have backrests and arms to give greater support for less mobile visitors.

- A shelf is helpful for resting items such as guidebooks and binoculars, especially for visitors with mobility disabilities.
- Visitor information should be designed to be accessible, both in its format and where it is placed in the hide. A height of around 1200mm will be a comfortable eyeline for people seated and standing.



Examples of good practice



Coscaron/Shutterstock.com

Careful consideration of viewing heights ensures that people of different ages and abilities can enjoy the experience.



Essex Wildlife Trust

Accessible hide at Thameside overlooks the Thames and Mucking mudflats.



Sensory Trust

A bird spotting guide positioned at a convenient height and with clear, large text and images that are easy to interpret.

An app for Deaf and hard of hearing birders

BirdNET is a free app that detects and identifies bird sounds. It was developed as a research tool so it has reliable and comprehensive information, and because it shows the visual patterns of individual bird songs it is a great tool for people who are D/deaf and hard of hearing. Through the phone's microphone, it detects sounds and displays them on a visual spectrogram. People can learn about specific birds through their visual spectrogram and this means they can engage in the art of identifying birds through the patterns rather than simply being told certain birds are in the area.

“Just like many birders can identify birds with sound alone, using the real-time spectrogram in BirdNET, I’ve learned to identify with my eyes what I cannot hear – the spectrogram patterns become to me what chirps and calls are to those who hear well”.

“Using the visual sound form, the habitat I’m in, the time of year, what food a bird prefers, and other clues, I can usually deduce what bird is around me and where it is so I can see it. It’s like identifying field marks on a bird, but with soundscapes instead”.

From an article by Annalise Kaylor, debugger.medium.com/birding-while-hearing-impaired-c243003fe140

Community birdwatching

Birdgirl was created by birder and environmentalist, Mya Rose Craig, to connect people from diverse ethnic and cultural backgrounds with the natural world. Nature camps and conservation activities build positive role models and support community cohesion. Socialising while birdwatching, sketching or doing citizen science projects helps remove cultural barriers and unfamiliarity

between different groups. This gives way to new understandings and helps reduce social divisions.

Bringing families together in nature proved especially valuable during the Covid-19 pandemic. From bird ringing and birdwatching, to enjoying halal fish and chips from a local pub and ice cream by a lake, these were restorative experiences in nature for families who were badly affected and economically impacted by the circumstances. www.birdgirluk.com

Flock Together is a birdwatching collective for people of colour. It is based on building community, challenging perceptions, showing the benefits of nature, championing ecological protection, offering mental health support and providing mentorship for the next generation. www.flocktogether.world/about

Examples of sites with bird hides and viewing points

Moyola Nature Reserve, Ulster – wheelchair accessible bird hide
www.ulsterwildlife.org/nature-reserves/moyola-waterfoot

Slimbridge Wetland Centre – series of wheelchair accessible bird hides
www.wwt.org.uk/wetland-centres/slimbridge/plan-your-visit/accessibility/

Bempton Cliffs, RSPB reserve, East Yorkshire – accessible routes, boardwalks, viewing platforms and a great example of access information www.rspb.org.uk/reserves-and-events/reserves-a-z/bempton-cliffs/accessibility

Euan's Guide – guide to accessible birding in the UK
www.euansguide.com/news/a-quick-guide-to-accessible-birding-in-the-uk/



Further guidance

Detailed design guidance developed by RSPB www.rspb.org.uk/birds-and-wildlife/wildlife-guides/birdwatching/advice-for-disabled-birdwatchers/

Disability Sports Northern Ireland (2021) Accessible outdoor places guide. Section 2.4.1 bird hides. Includes an example of a design layout for a bird hide layout. www.dsni.co.uk/wp-content/uploads/2021/07/Guide-5-Accessible-Outdoor-Places-Design-Guidelines.pdf

B.11 Fishing

Fishing is a popular recreational activity in the UK and ranges from fishing alone on a riverbank, to membership of an angling club and using sites dedicated to fishing. Inclusive facilities ensure that opportunities to participate are open to the widest range of people and it makes fishing easier, safer and more comfortable for everyone involved.

Since the start of the Covid-19 pandemic there has been a surge of interest in fishing among people who are new to the activity. This includes increased interest from women and more family-friendly, women-only and wheelchair-accessible events. This article provides more information www.gov.uk/government/news/the-great-outdoor-escape-popularity-for-fishing-here-to-stay-as-public-desire-long-term-connection-with-nature



What does inclusive practice look like?

- ▶ Accessible fishing platforms are located within easy reach of parking and toilets are served by accessible routes.
- ▶ Family members and companions are considered, for example with space for seating, depending on the type of fishing.
- ▶ All fishing platforms adhere to the basic standards developed by the [British Disabled Angling Association](#). Where this is not possible, accessible platforms are integrated with others rather than as segregated facilities.



Design Guidance

Location

- Ensure that accessible fishing platforms are located where disabled anglers can drop off their equipment and be close to parking. It is easier for disabled anglers if they can keep their cars by their platforms, or if there are a number of car parks spread around the site.
- Choose the most accessible parts of the site, for example the most level, or with the most accessible paths.
- Ensure the fishing platforms are served by accessible routes and gates and consider the proximity of facilities such as parking, toilets and cafes.

Platform design

- Fishing platforms should be just above water level, and not more than 600mm higher, to avoid anglers having to lean forward too far. Levels should take account of tidal and seasonal fluctuations, the lower the tidal fluctuation the better.
- The front of the platform should meet the water, with a safety edge at least 150mm high. In some situations, a safety rail may be required at the sides.

- The platform surface should be slip resistant in all weathers and if timber boards are used, they should be laid at right angles to the main direction of travel to minimise the risk of trapping wheelchair wheels.
- At least 25 - 30m of clear overhead space should be kept clear to the sides and rear to allow for casting.



Examples of good practice



iStock.com/Dean Hindmarch

Fishing opportunities within easy reach of parking and with plenty of circulation and manoeuvring space.



iStock.com/Andrew Hill

Accessible spots for people to sit and fish, ensures people can have their mobility scooter or car close by so that equipment doesn't have to be carried over a distance.

Some sites with inclusive fishing

Angling Trust's Get Fishing campaign - each year the Angling Trust runs hundreds of events for people of all ages and abilities to get into fishing for the first time or get back into angling. www.anglingtrust.net/getfishing/events/

Example of public information - the Department of Agriculture, Environment and Rural Affairs, Northern Ireland, has produced this guide showing fisheries in Northern Ireland that are accessible to disabled anglers. www.nidirect.gov.uk/sites/default/files/2022-01/short-guide-to-public-angling-estate-fisheries-accessible-to-anglers-with-disabilities.pdf



Further guidance

British Disabled Angling Association www.bdaa.co.uk/photo-gallery/guide

Disability Sports Northern Ireland, Accessible Outdoor Places Guide, section 4.5 Accessible angling facilities www.dsni.co.uk/wp-content/uploads/2021/07/Guide-5-Accessible-Outdoor-Places-Design-Guidelines.pdf

B.12 Boating and water-based activities

Inclusive opportunities to spend time on and in the water range from boating to swimming and surfing. There are many options for making existing facilities more accessible; wheelchair accessible pontoons, changing facilities and easy access drop-off. In addition, there are many innovative offerings now available from adapted sailing boats to accessible water sports.



What does inclusive practice look like?

- ▶ Activities are open to everyone and include adaptive equipment to support participation where necessary.
- ▶ Launching facilities are designed to maximise opportunities for disabled people and this may include the use of hoists, portable pontoons and other equipment to enhance overall accessibility.
- ▶ Appropriate expertise and training have been secured to ensure that the diversity of users is reflected in all planning, safety and safeguarding procedures.



Design guidance

General considerations

- Aim to complement other inclusive water-based opportunities in the local area. As these are relatively specialised activities, it makes sense to avoid duplicating services and instead provide ones not currently on offer in the vicinity.
- Ensure that staff are adequately trained to use specialised equipment.

Location

- Ensure that nearby parking and accessible routes are close to launch sites. Parking should reflect likely patterns of use, for example, parking for minibuses if group activities are likely and allowing for trailers if people bring their own equipment.
- Select a launch site that is easy to reach and that has the most accessible gradients and clearance to the water.
- Ensure there are accessible toilets and changing facilities within easy reach.

Design

- The specifics of design will depend on the type of activity and the nature of the site. Existing facilities can serve as useful models, and organisations such as those listed below provide valuable information. Specialist advice is essential.



Examples of good practice

Examples of inclusive boating and surfing

Paddle-ability sessions enable disabled people to take part in activities with other disabled people as part of a club or group or alongside their non-disabled friends and family www.britishcanoeing.org.uk/guidance-resources/disability

The Wheelyboat Trust is a UK charity that supplies groups and organisations with wheelchair accessible boats that give disabled people independent access to activities on the water www.wheelyboats.org/

Blind Sailing is a charity that provides sailing for blind and partially sighted people www.gbrblindsailing.co.uk/

Surfability UK is based on the Gower, Wales, and provides surfing lessons and experiences for people with additional needs due to disability, illness, injury or learning difficulties www.surfabilityukcic.org/



Further guidance

Canoeing and paddle sports www.britishcanoeing.org.uk/guidance-resources/disability

Canal and River Trust www.canalrivertrust.org.uk/enjoy-the-waterways/boating/do-you-know-a-vulnerable-boater/disabled-boaters-information

Sailing for All www.sailingforall.com

Wheelyboat Trust www.wheelyboats.org

Scottish Canoe Association www.canoescotland.org/

C. Guidance

Inclusive communication

.....

C.1 Inclusive information for visitors

Independent, accurate and relevant information is important for everyone and essential for people who need to make sure somewhere will be accessible and of interest to them. Without the right information, at best people may have to get in touch to find out, which is time-consuming for them and for staff. At worst, people may simply assume that places are not accessible to them.

The choice of content and the way it is shared will also influence who feels the information is relevant and meaningful for them.

Planning access information

There are some key steps involved in updating your existing information, or creating new materials:

Find out what information people need

A good starting point is to look at what information you already provide and whether it reflects the current accessibility of your site or route. Updating the accuracy of your existing information is a simple improvement you can make.

Engaging with as wide a range of people as possible is important to find out what information they need. This is usually easier if you have something to give people to review rather than simply asking in general terms. You can invite feedback on your existing visitor information or create some new draft materials for testing.

Visitor enquiries and feedback can also indicate what you should add to your information. If you don't have a system for collecting feedback about access it is a good idea to set one up as this can be useful for monitoring how well you are meeting people's needs.

Identify the best ways of sharing information

Information is only useful if people have access to it. Make sure online materials are well-promoted and easy to find on your website and social media channels.

Note that not everyone is online and according to the [Office for National Statistics](#) in 2015, 27% of disabled adults have never used a computer. Alternative means of sharing information are therefore important, such as leaflets. Ensure that any online or printed materials will be easy to find and can be updated regularly.

Connect with local networks who are happy to share your information and help you widen your reach. People are more likely to believe information that comes from people or organisations that they know and trust.

It can be helpful to connect with external websites that share information about the accessibility of sites and routes across the UK such as [Euan's Guide](#) and [AccessAble](#).

Creating access information

There are some key principles for creating effective information:

Make it accurate. Information should be honest and accurate so that people can trust it. Ensure there is a process for reviewing and updating online information on a regular basis. On printed materials, say that updates are provided on your website and give a contact number for people who don't have computer access.

Make it useful. Provide enough detail for people to make informed choices. For example, statements like "the trail gets steep in places" do not give enough information for people to judge what is accessible to them. It is better to give specific gradients, where they are and if there are options for people to do part of the trail without encountering them. This also highlights the importance of focusing as much as possible on what people can do, rather than what they can't.

Avoid judging what is or isn't accessible for people. What is challenging to one person may not be to someone else. Provide the facts without judging what that might mean, people are best placed to do that themselves.

Make it accessible. Apply the principles of clear layout and plain language and provide alternative formats on request such as large print, easy read and braille. These formats are covered in Sections C.3, C.4 and C.5.

What is useful for people to know?

The [Access Chain](#) is a good way of organising key information as follows:

Incentive to visit

- The experiences, activities, events and interesting features on offer, and their accessibility. Accessible facilities such as adaptive bikes, boats and fishing. Accessibility of children's play.
- Public feedback that demonstrates the positive experiences of other people with protected characteristics, and images that show diversity is actively welcomed.
- Opening hours and car parking or entrance charges, including any concessions.
- Public and community transport options and their accessibility. Links to service providers, and details such as timetables.
- Alternative information formats that are available, such as large print and alternative languages, and how people can access them.

- Information such as a site map available to download or available in hard copy through the post in advance of a visit.
- Contact details for finding out more information.

Journey and arrival

- Car parking, provision of designated accessible parking bays, height barriers.
- Locations of public and private transport drop-off and pick-up and proximity to entrances and points of interest.
- Wheelchairs or scooters available for hire and how they can be booked.
- Accessible cycling opportunities, accessible changing facilities and parking.
- Distance and accessibility from the car park to features of interest.
- Accessible toilets, Changing Places and gender-neutral toilets.
- Availability of the nearest food and drink options.

Getting around

- Paths and routes, types of surface, choice of routes, any challenges such as steep slopes, steps, gates, stiles and narrow widths.
- Gate and toilet locks that require RADAR keys.
- Weather-related accessibility, such as parts of a route or site that are difficult to access during wet conditions.
- Accessibility of signage and waymarking, information and interpretation.
- Availability of alternative formats, such as tactile maps, audio guides and leaflets in a range of languages.
- Staff and volunteer support, such as guided walk leaders are proficient in languages such as British Sign Language. Availability of access assistance.
- Seating and shelter and picnic tables, frequency along a route or throughout a site.
- Grading information if grading systems are in place.
- Facilities related to assistance animals, such as toileting areas, water etc.

Delivering information

Access guide

An access guide captures information about the accessibility of a site or route. It is usually made available as a free download from a website which has the advantage of being easy to review and update on a regular basis. Printed versions in alternative formats should be available on request and ideally for sending out to people in advance of a visit.

The information contained in the access guide should be used as the basis for headline details shared through other means, such as leaflets and posters.

VisitEngland and VisitScotland have produced useful guidance on creating and publishing an accessibility guide at www.accessibilityguides.org/

Filming, videos and photography

Video and photographs can be an excellent way of sharing information about the accessibility of a site or route. They have the advantage over written materials of being able to visually demonstrate what a place has to offer.

[Experience Community CIC](#) creates films and information about the accessibility of walks and outdoor activities. They emphasise the importance of providing links to websites, maps, photos and other information along with the films. This enables people to get as much detail as possible to inform their decision about what is suitable for them.

Virtual reality (VR) videos are also known as immersive videos as the 360 degree filming immerses the viewer in the look and feel of a place. [Heritage Ability](#) have worked with BSL signers to create VR videos of heritage settings in South West England. They made this film to show how the process works www.youtube.com/watch?v=7fV4pvY42-0

Accessibility of films and photography can be enhanced by adding features such as subtitles and sign language and by avoiding fast-moving or confusing visuals and complex narratives.

Leaflets

Printed leaflets allow people to carry information with them so they can take in details at their own pace and refer back as often as needed. They can be taken home by visitors, who may pass them on to others. Content should be clear and concise and follow the principles of plain language (see Section C.4). Widening the diversity of people shown in leaflet images will help people picture themselves being there too.

Providing written texts related to guided walks and events can benefit some people who are D/deaf and hard of hearing, who may otherwise miss out on the messages being shared. Online materials should be available as hard copy on request for people who do not have a smartphone.

Leaflets should be available in alternative formats and in a range of languages. More guidance on clear and large print is given in Section C.3.

Maps

A well-designed and clear map will show where paths go, what the accessibility options are and the highlights to be found. Interpreting a typical 2D map is not easy for everyone and the simpler and clearer the information the better. Overly complex maps are harder for everyone and while adding artistic detail can make a map look more attractive, it distracts from the information that people most need.

Adding pictures and photographs will help people relate a map to the place and it is important that these are kept up to date. Symbols and terminology

should be consistent on your visitor information to show highlights, hazards and potential barriers. These should relate to graphics and terminology used in signage around a site or route. Use internationally recognised graphics and symbols that people will be familiar with.

A static map at the start of a route can help people get their bearings but they may not remember the detail once they have started their journey. Signs and wayfinding will help and should relate to the same names and graphics used on the static map.

Maps printed in tactile materials can be helpful for people who are blind or partially sighted, but only if they are appropriately designed. Just making something tactile does not mean it will be helpful and it is important to seek the appropriate professional expertise. Tactile maps must be simple and cannot show as much detail as other maps. They should identify key details such as rest points, slopes and path widths as well as route layouts. Large print can be used by some people who are partially sighted.

Making maps downloadable from a website ensures that people can print them in ways that best suits them, keeping in mind that most people will print at A4. Online maps should have alt text so they can be interpreted by a screen reader.

Information boards

Information boards are a common way of sharing information at outdoor sites and routes, for example to display details such as opening times. They can be made more accessible by paying careful attention to where they are located, their height and the nature of the materials displayed. For example:

- Adding tactile and audio information can be helpful for people who are blind or partially sighted. These need to be located where they can be easily reached to explore this way.
- Make sure that people can get close to the boards to read them. For someone partially sighted this can be particularly important and highlights the importance of keeping the approach clear of obstacles and plants like nettles and thistles.
- All new boards should be accessible to wheelchair users. This includes keeping them clear of plants that can scratch or sting.
- An information point that can be clearly seen from the car park and entrance will help people feel more confident about using a site or route. A map will help people get their bearings and should highlight key facilities such as toilets as well as points of interest.
- If you use symbols for points of interest, repeat these along the trails and provide a key so that people know what the symbols mean.

Audio communication

The growing popularity of podcasts demonstrates the appeal of audio materials for many people, it can be especially valued by blind and partially sighted people and people who find text challenging.

Development in new technologies happens quickly and it is important to research options when developing audio; both for the best ways of producing materials and accessible ways of sharing them. Most importantly, work with people who are the intended audience to make sure that the materials will be as useful as possible.

Hearing systems are also important for some people who use hearing aids, these may be incorporated in a building or at specific locations such as ticket desks. Mobile hearing systems can be worn by guides and educators when taking groups around a site.

Digital information

The Internet is the main way that a lot of people will find information, so it is essential that your website is designed to meet the [WC3 or WCAG2.1 recommendations](#). These are well established as part of the international [Web Accessibility Initiative](#). It is also important to make sure digital information is compatible with screen-reading software.

Online information has a lot of flexibility as people can adjust font size and colours to suit them and the information can be updated easily.

Mobile phones are opening up more options for accessing information during a visit for visitors with access. For example, QR codes are increasingly used to share information.

Alternative formats for written information

Digital technology is not an option for everyone as some people cannot afford it, and others may not be able or want to use it. Alternative ways of providing information therefore continue to be important. In bigger sites, it might be possible to offer print-on-demand in an information hub or visitor centre for people to obtain information in a particular format.

Common alternative formats include the following:

- Braille. Not all blind people read braille, but for many who do, this tactile language is their primary means of reading text independently. Ideally, this should be edited to give more valuable information to a braille reader, rather than simply transcribing content aimed at someone using sight as a primary sense. Braille materials can be posted free of charge but the costs of producing braille will need to be factored in. See Section C.5
- Large-print sizes and strong colour and tonal contrast for people who are partially sighted. See Section C.3
- Symbol-based languages such as Widgit, and Easy Read that are primarily for people with learning disabilities and learning difficulties. See Section C.6
- Alternative languages that reflect languages used by the local community, and wider visitor profiles.



Examples of good practice

Examples of online accessibility information

Experience Community CIC provides films and information about walks and other leisure activities for disabled people and the wider community
www.experiencecommunity.co.uk/



Experience Community

Experience Community CIC creates films to show the accessibility of a route.

Minsmere RSPB nature reserve, Suffolk, is a good example of providing access information for visitors www.rspb.org.uk/reserves-and-events/reserves-a-z/minsmere/accessibility/

RSPB Bempton Cliffs access information includes a film produced by Experience Community CIC www.rspb.org.uk/reserves-and-events/reserves-a-z/bempton-cliffs/accessibility/

Social Guide A Trip to The Museum of Modern Art: An introduction for first-time visitors, families, or visitors with developmental disabilities. The visitor journey is described through a social story using clear text and images.
www.moma.org/momaorg/shared/pdfs/docs/visit/Social_Guide_to_MoMA.pdf

Information in alternative languages

Paths for All harnessed volunteer support to produce its health walk agreement (see Section B.8) in 10 languages, English, German, Polish, Arabic, Italian, Lithuanian, Portuguese, Romanian, Russian and Spanish.
www.pathsforall.org.uk/news/news-post/health-walk-agreement-now-available-in-10-languages

Grimsby Fishing Heritage Centre provides tour guides in different languages, including Arabic, Chinese, Dutch, French, German, Polish and Spanish. These are available on request and downloadable from their website
www.fishingheritage.com/other-language-guides/



Further guidance

Euan's Guide, disabled access review website www.euansguide.com/

AccessAble lists accessible venues across UK and Northern Ireland www.accessable.co.uk/

VisitEngland and VisitScotland have guidance on creating and publishing an accessibility guide www.accessibilityguides.org/

Experience Community CIC, films and information about the accessibility of walks and outdoor activities www.experiencecommunity.co.uk/

Sensory Trust provides guidance on inclusive communication www.sensorytrust.org.uk/resources/guidance/inclusive-communication

C.2 Guides and facilitators

Staff and volunteers as communicators

One of the most effective ways of embracing a wider diversity of communication methods is to have a greater diversity of staff and volunteers. Even in organisations where diversity feels narrow, valuable language and communication skills may exist.

People may be keen to use existing skills and learn new ones if the opportunity presents itself. The importance of supporting these interests can never be underestimated or undervalued. Staff and volunteers who meet members of the public play a vital role in sharing information and supporting different needs.

People working as guides, educators and visitor management support can develop greater confidence and skills through training in alternative languages and communication methods. If staff and volunteers are trained, this should be promoted to your visitors. See Section 3.2 for more information about training.

British sign language

British Sign Language (BSL) is the preferred language of over 87,000 Deaf people in the UK, for whom English may be a second or third language (www.bda.org.uk/help-resources/). It is now recognised as an official language, making it Britain's fourth indigenous language after English, Welsh and Scottish Gaelic. In Northern Ireland, both BSL and Irish Sign Language are used. Depending on the size of your organisation, it can be good practice to have a member of staff trained as a sign language interpreter to help visitors in visitor centres, or on guided walks and at events. Investing in BSL training will also encourage greater involvement of D/deaf people as volunteers and staff.

Sign and symbol communication

Sign and symbol communication methods have been developed primarily for people with learning and communication difficulties, their teachers, friends and families. Makaton and Signalong are the most commonly used in the UK. These communication methods are also increasingly used as a form of early communication with babies and toddlers. This is another option for staff and volunteer training. More information: www.makaton.org/ signalong.org.uk/



Examples of good practice

Royal Botanic Gardens Edinburgh is running a programme of guided tours in BSL www.rbge.org.uk/visit/garden-tours/bsl-seasonal-garden-tours/

Yosemite National Park is a leader in Deaf services in the American national parks. The park is visited by people from all over the world. It provides visitor information in American Sign Language www.nps.gov/yose/planyourvisit/deafservices.htm and runs a programme of staff training in Deaf and

disability awareness and outreach www.nps.gov/yose/learn/news/yosemite-national-park-expands-american-sign-language-services.htm

Various nature sites worked with Heritage Ability to film BSL tours and make them available online and on a tablet that people can borrow when they visit.

Lundy Island www.landmarktrust.org.uk/lundyisland/discovering-lundy/accessibility/bsl-guide/

Moors Valley Country Park and Forest www.moors-valley.co.uk/british-sign-language-tour-2/

Birdwatching at Seaton Wetlands www.countrysidemobility.org/locations/seaton-wetlands-0



Further guidance

Paths for All and NatureScot, Outdoor Access Design Guide www.pathsforall.org.uk/resource/outdoor-access-design-guide

Scottish Natural Heritage (now NatureScot) 2006 Access to the countryside by deaf visitors www.silo.tips/download/access-to-the-countryside-by-deaf-visitors

C.3 Printed materials – clear and large print

Inclusive design of all printed materials benefits people generally and particularly people who rely on information to help them plan or make the most of their outdoor experience.

Adopting clear and large print principles will make it easier for people to read your printed materials such as leaflets, guidebooks, maps and surveys. This will not remove the value of additional formats like braille and alternative languages, but it will significantly increase the number and diversity of people who can access your information.



What does inclusive practice look like?

- ▶ Clear print principles are applied to all printed materials.
- ▶ Large print materials are available on request.
- ▶ People can enjoy information together because alternative formats are available alongside standard materials.
- ▶ Images and terminology reflect the diversity of people who are likely to use the information.
- ▶ Printed materials follow dyslexia friendly guidance.



Design guidance

Clear print principles

- Adopt a house style that conforms to the [UKAAF](#) clear print guidelines.
- Clear print is defined by the UKAAF as 12pt, ideally 14pt. RNIB defines it as 14pt, ideally 16pt. The principle is the larger the font, the more people can access it. Note that fonts have different sized letters so compare against Arial font and adjust accordingly.
- Choose fonts that are noted as being clear and easy to read. Sans serif fonts, such as Arial and Verdana, are usually clearer. Avoid unusual and very decorative ones as these are harder to read.
- Ensure good colour and tonal contrast between font colour and background as this makes a huge difference to how easy something is to read.
- Aim for more than single spacing between lines and paragraphs to maximise legibility.
- Reading long documents can be tiring, especially for people with partial sight, so aim to keep content clear and concise.
- Align text to the left as much as possible as this makes it easier to track the start of sentences.

- Do not overlay text over images as it is difficult and confusing to read.
- Avoid using italics and ALL-CAPS, except in exceptional circumstances, and do not use underlining. These all make text harder to read.
- Print on non-glossy paper to minimise glare.
- If text is reversed out (eg white on black background) the font may need to be bold to ensure it is clear enough. Note that this style can be more tiring to read and uses more ink so it is best to avoid it generally.
- Ensure suppliers are briefed with accessible information and clear print guidelines.
- Apply the same principles to footer notes, page numbers and other information.

Large print principles

- Refer to the [UKAAF](#) standards for more detailed guidance.
- Large print is defined by the UKAAF as 16pt, ideally 18pt. RNIB highlights that most requests are for print in the range of 18–20pt.
- You should not refer to a document as being large print unless it conforms with this standard.
- Large print documents should also conform to other clear print guidelines regarding layout, use of fonts and images.
- Check you have copyright permissions to reproduce materials in large print.
- Produce a specific large print version of your information rather than photocopying an enlarged copy or simply adjusting the font size.
- When promoting a large print version in a leaflet ensure that this is clearly displayed at the beginning or on the front, in a text that conforms to large print standards.

Online information

- Design digital information to be accessible, with clear layout, straightforward navigation and compatibility with screen reading software. Refer to the [Web Content Accessibility Guidelines](#).
- Ensure these principles are applied to the print page settings so that printed materials generated from your website and apps are easy to read.
- Use clear, simple layouts that avoid information overload and make it easy for people to find what they are looking for.



Further guidance

Dyslexia friendly style guide www.bdadyslexia.org.uk/advice/employers/creating-a-dyslexia-friendly-workplace/dyslexia-friendly-style-guide

UK Association for Accessible Formats www.ukaaf.org/

Minimum standards for clear and large print www.ukaaf.org/wp-content/uploads/2020/03/MS03-UKAAF-Minimum-standards-Clear-and-large-print.pdf

Sensory Trust www.sensorytrust.org.uk/resources/guidance/designing-with-clear-and-large-print

C.4 Designing with plain language

Plain language communicates information simply and clearly. It doesn't deny the richness of a language, or dumb down content, but it does avoid unnecessary jargon and overly complex or convoluted ways of saying things. Using plain language makes it more likely that your readers will understand what you are saying.

These principles are championed by the [Plain English Campaign](#). We are using the term plain language here as the principles apply to all languages.



What does inclusive practice look like?

Key benefits of using plain language are:

- ▶ All your information materials are easy to understand and use.
- ▶ There is good uptake of your public information, from leaflets to website.
- ▶ Transcription into alternative languages, like large print, is an easier process.



Design guidance

Content planning

- Identify your key messages, your audience and what they want and need to know.
- Identify what you want them to do as a result of reading your information.
- Identify the language your audience is likely to be familiar with.
- Remove information that is irrelevant or surplus.

Structure your information

- Summarise key points at the beginning.
- Start with the most important information your reader needs to know.
- Use clear headings to break up the text into clear chunks.
- For lengthy content, provide a summary.

Writing style

It is important to work with your own style to say what you mean to say, in as clear and direct a way as possible. Writing content for websites and blogs can be good practice. The following principles can help:

- Use language your audience will understand.
- Split your information into short, easily absorbed paragraphs.
- Keep most sentences around 15–20 words, but don't be too strict on this as a mix of sentence length helps readability.

- Try to avoid combining too many different ideas in a sentence and paragraph.
- Be as brief as possible. The clearest sentence order is subject, verb, object. For example: “I am an environmental manager” is better than “environmental management is what I do” or “environmental management is the profession I am employed in”.
- Avoid abbreviations unless they are very familiar, like eg.
- Avoid jargon. This can be hard to judge and it is best to ask someone else who is unfamiliar with the subject to check for terms they don’t understand.
- If you must use particular words for the sake of accuracy, or if you include acronyms, explain them in the text the first time you use them, for example Natural Resources Wales (NRW).
- Keep punctuation simple and accurate. Many people are confused by semi-colons, colons, square brackets and sloppy or ambiguous use of punctuation.
- Use direct language and the active rather than passive voice. For example, “we will decide” rather than “a decision will be made”.
- Repeat words rather than using alternatives for the sake of variety and be careful using words like ‘it’, ‘this’ or ‘they’ to refer to something you mentioned earlier.
- Avoid phrases where a single verb will do. For example, ‘deliver’ rather than ‘arrange a delivery to’.

Check your writing

There are online reading checks that can help to an extent, for example at www.timetabler.com/reading.html However, the best option is to find someone appropriate to read aloud what you have written. Phrasing in written work can look fine on the page but sound clunky when read aloud. Test everything.

For example

The sentence ...

“High-quality nature-based learning experiences are a necessary precondition for facilitation and enhancement of the ongoing learning process.”

written in plain language ...

“Spending time in nature helps children learn well.”

Source: [Plain English Campaign](#)



Further guidance

Plain English Campaign www.plainenglish.co.uk/

Plainlanguage.gov www.plainlanguage.gov/resources/checklists/checklist/

Sensory Trust guide to plain language www.sensorytrust.org.uk/resources/guidance/designing-with-plain-language

C.5 Designing with braille

Braille is a long-established tactile reading and writing system that is used by blind people around the world. Not all blind people read braille, but for the 12,000 braille readers in the UK, it is an important means to read information independently.

Including braille shows that braille readers are recognized and welcomed. More widely, the use of different forms of communication promotes a positive message about diversity and highlights the reality that we rely on different ways to interpret the world around us.

Braille is easier and cheaper to produce than many people expect and there are exciting new braille technologies developing. It should be considered as part of any accessible information plans.

New technologies will make it easier to share information like opening times as well as interpretation and education materials. Electronic devices that are in development include braille smart watches and devices that can instantly translate printed text into braille.



What does inclusive practice look like?

- ▶ Pre-visit braille materials are available to enable a braille reader to plan their visit.
- ▶ Braille materials provided during a visit enable braille readers to gather information at their own pace, without relying on a sighted person to read things for them.
- ▶ Staff are sufficiently familiar with how braille works to support its inclusion.



Design guidance

Types of braille

- Braille has two levels. Grade 1 works letter by letter and can be read by all braille readers but is regarded as too simplistic and slow by some. Grade 2 contracts common words, takes up less room and is quicker to read. Grade 1 should be used for single words, for example tactile instructive signs and Grade 2 for longer texts.

Braille printed materials

- It is important to work with a braille reader or authority to develop new materials.
- Avoid simply transcribing information from a sighted perspective and instead describe from a wider sensory experience.
- Plan production as early as possible in the design process so that it can be incorporated in the best way. Allow at least a couple of weeks for production.

- Allow for thorough proofing by a braille user and allow time for revisions.
- Include descriptions of images that illustrate a point or a theme.
- Make sure information is kept up to date.

Braille technologies

Technological advances will offer exciting opportunities for integrating braille into the visitor experience. This will range from sharing information such as opening times to interpretation and education materials.

- Electronic braille note-takers are used to write and read in braille. They are becoming more portable and affordable, which will make them available to more braille users. The RNIB provides information about the current technologies that are available www.rnib.org.uk/sight-loss-advice/technology-and-useful-products/technology-resource-hub-latest-facts-tips-and-guides/braille-displays-and-notetakers

Braille for interpretation, signs and maps

- For buildings and structures, follow the advice of the [Sign Design Guide](#) for consistent placement of braille on signage, such as doors.
- With signs and maps, use braille consistently so that braille readers quickly get used to where they can expect to find the information.
- Integrate braille so that families and friends can enjoy information together. Many braille readers will visit with someone else but shouldn't have to rely on them to pass on information.

Publicise braille materials

- Let people know that braille materials are available and how they can access them, including if they can be sent as pre-visit information.
- Ensure that staff know what information is available in braille and how to send it to people.

.....
 "I love going anywhere with a heritage theme, a museum or just walking our local mining trail. I am blind, an active hiker and a longtime fan of anything historic. My wife doesn't share the same interests but has to read aloud the information we find – who built the viaduct, what was it made from and where did they find the stone. It is boring for her and frustrates me that I can't find out for myself. Today, joy of joys, I came across a heritage guide written in braille and it transformed our experience. I happily absorbed the information and Josie got out her sketchbook. Best trip out ever." braille user

Feedback from a braille user.



Examples of good practice



A tree label designed with braille and Widgit symbols by Sensory Trust.



Further guidance

Introduction to braille www.ukaaf.org/standards/

Braille still as vital as ever, RNIB Scotland www.rnib.org.uk/scotland/scotland-news-and-media/braille-still-vital-ever-insists-rnib-scotland

Designing with braille, Sensory Trust www.sensorytrust.org.uk/resources/guidance/designing-with-braille

C.6 Designing with symbol and pictorial communication

Symbol-based communication can be used in visitor information and interpretation to make a more welcoming and engaging experience for young people and adults with learning disabilities, their friends and families. In practice, symbols are useful to a wider range of people, such as those with low literacy or who don't use English as a first language.

Symbol languages use pictorial symbols as an alternative to text, or to accompany it. A growing number of people with learning disabilities use them and they are used extensively in special schools and increasingly in primary schools to help children who need support with literacy.

There are different symbol languages, and it is important to choose the most appropriate one, for example by finding out which ones are used by the groups you are working with.



What does inclusive practice look like?

- ▶ Pre-visit materials are available to enable an individual, family or group to plan their visit.
- ▶ Materials are provided during a visit to enable people to gather information at their own pace.
- ▶ Symbols are incorporated in site information and interpretation.



Design guidance

Using symbol communication

- Using a symbol-based communication in consultation work enables people with learning disabilities to communicate their experiences and feelings directly without having to rely on someone else to speak on their behalf.
- If you are interested in implementing symbol communication, it may help to find out if your local authority uses a particular platform across all local schools.
- If your site or route attracts people from a wider geographic area, you might decide to use a particular symbol communication method. We recommend Widgit because of its widespread use and the vast vocabulary available.

Designing with symbol-based communication

- It is essential to be consistent. Use one type of communication method rather than a mix of different ones.

- You can use photographs or illustrations to support text but try not to use both as it can be confusing.
- Keep both text and visuals simple. The following example in Widgit symbols shows how confusing it can be to illustrate every word with a symbol, and how much clearer it is to consolidate them as appropriate.



- Preparing content using symbols requires skill so it is important to seek advice from specialists.
- If you plan to produce materials in-house it is important to obtain the relevant training for staff.
- Always aim to test materials with their intended audience before finalising any resources. A local special school may be happy to help with this.

Easy Read materials

Easy Read presents written information in a way that makes it easier to understand. While it is often aimed at people with learning disabilities, it is helpful more widely for people with limited literacy or those who don't have English as their first language. Easy Read uses short sentences and each sentence has a single idea. Words are accompanied by symbols or pictures.

More information: www.learningdisabilities.org.uk/learning-disabilities/a-to-z/e/easy-read

Social and sensory stories

Social stories are short, easy to understand descriptions to help autistic people know what to expect from a situation, event or activity. They were created by Carol Gray in 1991 and are widely used. A social story can be an effective way of sharing information to show what a typical visit is like and what to expect.

A sensory story has straightforward text accompanied by text that illustrate key aspects of a visit. See the National Autistic Society's website for more information: www.autism.org.uk/advice-and-guidance/topics/communication/communication-tools/social-stories-and-comic-strip-conversations

Publicise materials

- Let people know that materials are available and how they can access them, including if they can be sent as pre-visit information.
- Ensure that staff know what information is available and how to send it to people.



Examples of good practice



Sensory Trust

Widgit is an example that is used internationally in 15 languages (overseas symbol users can recognise the Widgit symbols used in the UK) and with over 7000 images covering a vocabulary of over 20,000 words. There is more advice on using Widgit in nature settings at www.sensorytrust.org.uk/resources/guidance/using-widgit-and-symbol-languages



Walking during periods of social distancing



What is this easy read about?

This easy read is about how to stay safe and have fun when you go out for a walk.



What is Coronavirus?

Coronavirus is the illness

Paths for All

An easy read guide produced by Paths for All to explain the importance of social distancing when going out for a walk during the Covid-19 pandemic.



Further guidance

Making written information easier to understand for people with learning disabilities: guidance for people who commission or produce Easy Read information, Revised Edition 2010, Department of Health www.gov.uk/government/publications/making-written-information-easier-to-understand-for-people-with-learning-disabilities-guidance-for-people-who-commission-or-produce-easy-read-information-revised-edition-2010

Signalong training and resources www.signalong.org.uk/

Widgit www.widgit.com/

Using Widgit and symbol languages, Sensory Trust www.sensorytrust.org.uk/resources/guidance/using-widgit-and-symbol-languages

Makaton signs and symbols www.makaton.org/

C.7 Wayfinding

Clear, consistent wayfinding signage, such as signs and finger posts, is especially important for people who are less familiar with a site or route, or who need to be certain of finding key facilities such as toilets and the return route to a car park.



What does inclusive practice look like?

- ▶ Intuitive site layouts make it easier for people to find their way and minimise the need for waymarking signage.
- ▶ Strategically placed signs ensure that people know where key facilities are, such as car parks, toilets and cafes.
- ▶ Integration of symbols and images enhance wayfinding for people who find text difficult.



Design guidance

General principles

- Simplicity and consistency are key. Minimise the amount of information provided and use the same style throughout.
- Aim for site and route layouts to be intuitive to reduce the need for waymarking signage, for example by using path surfacing to define a particular area or route.
- At the start of a route include the destination, distance and estimated walk time.
- Include any information about the route, for example gradients, rest points and viewpoints to help disabled people decide if the trail is right for them.
- Avoid using a lot of waymarking arrows on a single post as this can be confusing.
- Avoid sign clutter as it is always confusing.
- All junctions should be waymarked.
- Good maintenance is essential so that information remains legible at all times.

Wayfinding details

- Dovetail with appropriate route grading systems already in use by your organisation or locally. This may relate to colour coding, symbols or other ways of communicating different types of route. However, take care not to misuse these systems, for example applying a cycling-based grading system to one intended mainly for walking.
- Align arrows with the direction of intended travel. Note the convention is for arrows to point upwards when directing people to go straight ahead.

- Symbols as well as waymarking arrows help people follow routes (eg a picture of a sandcastle for a walk that leads to a beach).
- Small waymarker signs are easy to miss and should be at least 100mm in diameter.
- Create a strong colour and tonal contrast between symbol and background.
- Consider choice of colours in relation to colour blindness, avoiding a choice between red and green for example. It is good practice to avoid using colour alone as a way of indicating different routes or conditions.
- Make the post clearly visible against background vegetation.



Examples of good practice



Experience Community

Signage at decision points helps people know where to find different areas and features. The combination of text and symbols increases accessibility.



Paths for All

Clear signage with pictograms installed as part of a dementia-friendly design by Paths for All.



Sensory Trust

A timber tactile panel shares information about the location where the Tamar river marks the boundary between Cornwall and Devon, as well as some of the nature highlights. Adding greater visual contrast to the words and features would enhance its accessibility to people with partial sight.



Further guidance

Signage guide for outdoor access, Paths for All www.pathsforall.org.uk/resource/signage-guidance-for-outdoor-access

Sign design guide (only available hard copy) www.signdesignsociety.co.uk/book/the-sign-design-guide/

Manchester City Design for Access guide www.manchester.gov.uk/downloads/download/5366/design_for_access_2

Disability Sports Northern Ireland, Accessible outdoor places guide section 3 www.dsni.co.uk/wp-content/uploads/2021/07/Guide-5-Accessible-Outdoor-Places-Design-Guidelines.pdf

The path manager's guide to grading www.pathsforall.org.uk/resource/the-path-managers-guide-to-grading

Inclusive Symbols are designed to make public places more inclusive and easier for people to navigate. Created and tested with the expertise of people living with dementia, the symbols are clear, easy to understand, and free to use www.inclusivesymbols.com/

D. Review tools

D.1 Reviewing a site or route using the Access Chain

The [Access Chain](#) follows the visitor experience, from deciding to visit somewhere, to the experience when there and subsequent return home. It is a useful way of framing a review process. It can be used to review a site or route or to help you plan visitor information.

The following provides a framework for a relatively detailed review of the different steps of a visit. You can simplify it by reducing the detail in the second column.

A blank sheet is provided at the end as a suggested way of recording the information.

Step 1: Decision to visit

A decision to visit is the first step in the Access Chain and usually depends on what information is available. Lack of accessible pre-visit information is one of the most significant barriers limiting use of the outdoors by disabled people, who often need to plan more carefully to make sure a visit will be enjoyable. It also relates to people who lack confidence and need reassurance that a site or route will be welcoming and accessible.

A decision to visit may be made solely by an individual, or with a family member, friend or supporter. The information should take all these people into consideration. A poor experience by a friend or supporter may also break the Access Chain for the person who is directly impacted by barriers to access.

Indicators of good practice

Information welcomes all visitors	Websites, social media and leaflets show a wide range of people, stories and activities. Information is designed to principles of inclusive design and plain language. Information is shared widely with local community groups and networks. Information is checked regularly to ensure it is kept up to date.
--	--

<p>Information is accessible</p>	<p>Websites are designed in line with Web Accessibility Initiative standards and user-tested with disabled people.</p> <p>Information is available online and as hard copy for people who don't have access to a computer or smartphone.</p> <p>Alternative formats and languages are available.</p>
<p>There is information about site accessibility</p>	<p>People can find key information before they visit, such as opening times, facilities and travel options.</p> <p>An online access guide covers the accessibility of routes, facilities, and activities.</p> <p>Video or picture guides are available so people can get a sense of the experience before they visit.</p> <p>Policies are clear about free or reduced entry fees for carers and personal assistants, older people and people in relative low income.</p>
<p>Information is well located</p>	<p>Website information is easy to find.</p> <p>Community venues, groups and networks are actively sharing information with new audiences.</p>
<p>There is virtual access to experiences that are too challenging to get to</p>	<p>People can gain a virtual experience (eg of a remote cave, or a steep hill fort) through video, webcam, audio, images etc.</p>
<p>There is a policy for developing inclusive information</p>	<p>An information policy is regularly reviewed to ensure that all new information takes on board highest standards of inclusive design.</p>

Step 2: Journey and arrival

A key factor when choosing to visit a destination is how easy it is to get to and home again (the door-to-door journey). Lack of accessible public transport can be a major barrier to people without a car. Equally, a lack of accessible car parking can prevent visits by disabled people. The most accessible routes, sites and facilities are usually those that offer a range of travel options.

Indicators of good practice

<p>It is possible to reach the route or site by public transport</p>	<p>Accessible on-site transport options are available (such as bookable mobility vehicles) and these are highlighted in off-site information.</p> <p>Wheelchair-accessible bus and taxi services are available.</p> <p>Reduced price and alternative route options have been agreed upon with local transport providers, including community transport organisations.</p>
<p>Walking, wheeling and cycling are supported</p>	<p>There are good routes and associated facilities for arriving by walking, wheeling or cycling.</p> <p>Accessible cycling opportunities are available.</p> <p>Accessible showers, lockers and cycle storage are provided.</p>
<p>Accessible car parking and drop-off are clearly identified</p>	<p>Accessible parking is clearly signed from approach roads and located near to arrival points and key highlights (eg café).</p> <p>At least 6% of spaces are designed and designated for disabled visitors.</p> <p>Electric charging points are available for wheelchair users and charging points for electric vehicles are accessible.</p> <p>Drop-offs for public and private transport are accessible, near the entrance, and on the same side of the road to avoid people having to cross traffic.</p>
<p>Entrances are welcoming and clearly signed</p>	<p>Arrival points have good information, such as an accessible map and wayfinding details.</p> <p>Facilities such as cafés, visitor centres and toilets are accessible and easy to find.</p> <p>Main entrances can be used by all visitors (ie not separate for wheelchair users).</p>
<p>Choice of visitor experiences is clearly highlighted</p>	<p>Visitor information is available to show people what experiences are on offer so they can choose what best suits them.</p>
<p>Equipment is available</p>	<p>Equipment such as wheelchairs and mobility scooters, portable seats, puncture-repair kits and audio materials are available for loan.</p>

<p>Remote and challenging visitor experiences are reflected in the visitor or learning centre or café</p>	<p>People can link to more remote and challenging experiences, eg video footage, audio material, webcam of a bird’s nest.</p> <p>Materials are available to explore through touch eg a touch table with interesting objects and materials.</p>
<p>Staff and volunteers provide good support</p>	<p>Staff and volunteers are trained in diversity awareness.</p> <p>Trained access volunteers are available to provide support.</p>

Step 3: On-site experience: facilities and events

Facilities are an essential consideration for some people when planning a day out. Lack of accessible toilets has a significant impact on how long people can spend somewhere, or if they can visit at all.

There may be accessible toilets and refreshments available in nearby pubs, cafés or town centres and the task is simply to include this in the publicity and information about the site or route. However, it is important to recognise that some public toilets are closing and in some areas, this will increase the importance of providing such facilities. Where there is a lack of utilities and services, solar and wind power with self-composting or long drop toilets can be an environmentally friendly and cost-effective way of providing these facilities.

Indicators of good practice

<p>Toilets cater for all visitors</p>	<p>There are accessible toilets near entrances, car parks and starting points.</p> <p>Toilets are highlighted in access information and include details of accessibility.</p> <p>There is a Changing Places toilet.</p> <p>There is a gender-neutral toilet.</p>
<p>Facilities such as visitor centres, cafés, ticket sales and bird hides are accessible</p>	<p>Opening times are convenient for different people.</p> <p>Accessibility is promoted in visitor information.</p> <p>Staff have undertaken diversity awareness training.</p>
<p>Good provision of seating and shelter</p>	<p>There are frequent opportunities for visitors to rest along routes.</p> <p>Seating is prioritised on more challenging gradients and surfaces.</p> <p>Shelter is available, particularly in places where people are likely to dwell (eg pickup points).</p>

Diverse range of activities and events	Diverse community activities are supported. Activity plans reflect diverse interests. Community consultation identifies the appetite for different activities and highlights any factors limiting access.
Play areas are inclusive	Play areas are accessible to disabled children and disabled parents and provide a diverse range of play opportunities from quiet and creative play to physically active.
Event spaces cater for all visitors	There are accessible toilets nearby, car parks or drop-offs and plenty of seating. There is step-free access to event and activity spaces, including performance spaces.
Diverse range of food and drink on offer	the food offer takes account of the most common food intolerances (eg gluten and nuts) as well as dietary options such as meat-free. Specific diets and intolerances can be catered for by arrangement, but this should be promoted on the appropriate literature or advertising.
Alternative languages are available	Interpreters can be booked. Sign language is planned for large-scale events.

On-site experience: getting around

The ease with which visitors can get around depends mostly on the physical nature of a site or route. Gradients, narrow path widths, distances and uneven surfaces can all present barriers to disabled people, older people and families with young children. Improvements to the fabric of a site or route will be one of the main ways of opening up access to the widest range of people.

Identifying and promoting attractive routes with the easiest access will benefit a wide range of people. This includes: disabled people, families with young children and pushchairs, people with health conditions that reduce physical exertion, older visitors and people that aren't used to walking in less formal landscapes. This avoids 'easier access' being seen as something related specifically to disabled visitors, and instead related to everyone.

Indicators of good practice

<p>Toilets cater for all visitors</p>	<p>There are accessible toilets near entrances, car parks and starting points.</p> <p>Toilets are highlighted in access information and this includes details of accessibility.</p> <p>There is a Changing Places toilet.</p> <p>There is a gender-neutral toilet.</p>
<p>There is regular review of accessibility and a positive response to issues raised</p>	<p>Disabled people are engaged with regular access reviews.</p> <p>There is a clear process for reporting and responding to accessibility issues.</p>
<p>Regular and high-quality maintenance</p>	<p>There is regular repair to surfaces, cutting back overhanging vegetation, removing obstacles, litter etc.</p> <p>Maintenance teams are trained in diversity and access awareness.</p>
<p>Choice of routes in terms of distance, challenge and visitor experience</p>	<p>Short return routes are included as easier options.</p> <p>Routes with different levels of challenge are offered and communicated in information materials.</p>
<p>Good wayfinding</p>	<p>There is good information at key decision points so people can find their way around.</p>
<p>Personal safety is supported</p>	<p>Support measures ensure that personal safety is maximised and people feel safe. For example, good sightlines along routes, lighting, contact numbers and options for accompanied walks.</p>
<p>Seating is provided</p>	<p>Regular seating provides resting points, particularly to reduce the impact of gradients and distances.</p>

Information and interpretation - indicators of good practice

<p>Information is inclusive</p>	<p>Information is designed to principles of inclusive design.</p> <p>Guides are available in different formats and languages.</p> <p>Symbols and pictures accompany text.</p> <p>Videos are captioned for the benefit of people who are D/deaf and hard or hearing.</p> <p>Hearing systems are installed in visitor centres, and portable ones are used by guides and educators.</p>
<p>Alternative formats are available</p>	<p>Information is available in alternative formats to text such as braille, large print, audio, Easy Read and symbol-based languages.</p> <p>Interpretation uses other formats beyond text, such as tactile and QR codes.</p>
<p>Information is well located</p>	<p>Position of display boards is comfortable for a range of viewing heights.</p> <p>Leaflets and takeaway information is in accessible locations, eg counters reachable by wheelchair users.</p>
<p>Good wayfinding</p>	<p>There is information at key decision points so people can find their way around.</p> <p>Symbols, names of features and other information are mirrored in the signage. A clearly designed leaflet with good information can reduce the need for signs.</p>
<p>Guided tours are accessible</p>	<p>Alternative languages, sign language and hearing systems are available for guided tours.</p>

Step 4: Return Home

A positive final experience when leaving a destination is important for all visitors. It is particularly important in relation to positive word of mouth as it is increasingly common for people to share their views (both positive and negative) on social media and online review sites. These will influence other people's decisions about visiting.

Exit routes need careful thought, ensuring that all visitors can find their way easily. Issues such as access to toilets, timing of public transport, comfortable spaces where visitors can be picked up by taxi or car, and information that people can take away with them are also important to consider.

Indicators of good practice

Exit routes are clearly signed and easy to use	<p>Exit points are clearly marked on maps and visitor information, and well signed on site.</p> <p>Facilities such as cafés, visitor centres and toilets are accessible and easy to find.</p> <p>Exits can be used by all people (ie not separate for wheelchair and scooter users).</p>
Exit routes are within easy reach of parking and public transport	<p>Accessible parking is located close to exit points.</p> <p>Public transport and pick-up points are within easy reach of exits.</p>
Good provision of seating and shelter	<p>Seating and shelter are provided at pick-up points and other places where visitors are likely to wait.</p>

Access chain review: example of record form

Map ref	Access issue	Action
Step 1 – decision to visit		
-	No website access information about accessibility.	Update website information.
-	Low community uptake for our new mental health walks.	Be more proactive with publicity, get in touch with community groups and follow up on health links.
Step 2 - arrival		
-	Our cycle hire doesn't have adaptive equipment.	Research options, get advice, work out costings and add to budget.
a1	Accessible parking markings have faded and signage needs updating.	Renew the markings, checking dimensions, and replace signs.
Step 3 – getting around		
a2	Erosion at boardwalk bridge has created a trip hazard and wheelchair barrier.	Priority repair, add to maintenance plan.
Step 4 - leaving		
a3	Lack of seating alongside the slope back to the car park.	Add two seats.

D.2 Route review checklist

This is designed for relatively easy and quick recording of the general characteristics of a single route or route network. It can be used to prioritise routes for more detailed review.

Accessibility survey information collection		
	Connectivity	Identify the locations and features that the route gives access to. A route will be particularly important if it links to transport and parking, has facilities such as toilets and pubs, or leads to significant areas and features.
	Popularity	The amount of use that a route receives can be assessed through visitor surveys, staff knowledge and consultation.
	Demand	This requires surveys and consultation with users and people who would like to use the route but are currently unable to.
	Shared use	People often benefit from knowing that a path has to be shared with horse riders, cyclists, motor vehicles or other users.
Accessibility	Surface	The type of surface and its condition will indicate potential access improvements.
	Width	Widths may vary considerably, but most important is the average and any particularly narrow sections.
	Linear gradient	Overall gradient along the line of a path should be measured at intervals of about 50m with additional measurements of sections over 1:20.
	Cross gradient	Crossfalls should be noted where they exceed 1:50.
	Barriers	Record any feature that is likely to cause a significant barrier. For example, narrow sections or pinch points, gates, steps and obstacles.

E. Further guidance

Access to the outdoors

Access Chain: an inclusive design tool, Sensory Trust

A tool that you can use to look at access from the perspective of the visitor. You can use it to review access improvements, plan events and frame visitor information.

www.sensorytrust.org.uk/resources/guidance/access-chain-an-inclusive-design-tool

Accessible Outdoor Places Design Guidelines, 2020, Disability Sport Northern Ireland

Guidance on improving access to the outdoors for disabled people. Includes principles of inclusive design and detailed technical advice for designers and site managers.

www.dsni.co.uk/wp-content/uploads/2021/07/Guide-5-Accessible-Outdoor-Places-Design-Guidelines.pdf

Accessibility of Venues, Scottish Health Council, 2014

Accessibility checklist to assess the accessibility of a venue (Participation Toolkit).

www.inclusivecommunication.scot/resources?catname=Housing+and+the+Built+Environment+Resources

Autism Friendly Award for businesses

The award makes businesses more accessible and helps open up public spaces to autistic people and their families.

www.autism.org.uk/what-we-do/solutions-for-business/autism-friendly-award

By All Reasonable Means (2017) Natural Resources Wales, and By All Reasonable Means (2020) Natural England

Both guides are updates of the 2005 guide published by the Countryside Agency (now Natural England), all authored by Sensory Trust. The guides introduce Least Restrictive Access as an approach to help countryside managers maximise opportunities for disabled people to access the countryside. Free to download from Sensory Trust and Natural Resources Wales.

www.sensorytrust.org.uk/resources/guidance/by-all-reasonable-means-least-restrictive-access-guidance

www.naturalresourceswales.gov.uk/days-out/recreation-and-access-policy-advice-and-guidance/improving-access-for-all/?lang=en

Easy Access to Historic Landscapes (2015) Historic England

Advises on improving access in heritage settings and while it responds to the Equality Act 2010 it focuses on disabled visitors. Its companion publication 'Easy Access to Historic Buildings' provides valuable information for buildings.

Free PDF to download from the Historic England website.

historicengland.org.uk/images-books/publications/easy-access-to-historic-buildings/

Inclusive mobility: A guide to best practice on access to pedestrians and transport infrastructure Department for Transport, 2021

Relates mainly to the urban environment, and the higher access standards outlined in this guide, but provides valuable information about inclusive design guidelines and specifications.

www.gov.uk/government/publications/inclusive-mobility-making-transport-accessible-for-passengers-and-pedestrians

Lowland Path Construction Guide, Paths for All and NatureScot, 2019

An update of the 2001 'Lowland Path Construction - A Guide to Good Practice'. A comprehensive guide to all aspects of lowland path development and management, covering all stages of path construction, planning, design, construction and maintenance. It helps guide decisions about long term management of path networks.

www.pathsforall.org.uk/mediaLibrary/other/english/lowland-path-guide.pdf

Managing Change in the Historic Environment (2010) Historic Environment Scotland

Sets out the principles that apply to developments for improving physical access to the historic environment. It should inform planning policies and the determination of applications relating to the historic environment.

www.historicenvironment.scot/archives-and-research/publications/publication/?publicationId=f0185b2c-3ed9-40c4-899d-a60b00885214

NatureScot – Scottish Outdoor Access Code and Guidance

Guidance on outdoor access legislation and rights and responsibilities, routes, signage, community walking programmes and managing access in the countryside. Free to download from the NatureScot website.

www.outdooraccess-scotland.scot/

Publications & resources

www.outdooraccess-scotland.scot/access-management-guidance/signs

Technical advice

www.nature.scot/professional-advice/land-and-sea-management/managing-access-and-recreation/access-and-recreation-management-technical-advice

Good practice guidance for Wales to ensure fully inclusive built environment funded through Welsh Govt Advancing Equality Fund

www.disabilitywales.org/wp-content/uploads/2018/03/WAY-TO-GO-Toolkit-E-with-links.pdf

Outdoor Access Design Guide, Paths for All and NatureScot, 2016

The guide is an update of the Countryside Access Design Guide produced by Paths for All in 2002. It advises on outdoor access furniture and structures, such as gates, fences and boardwalks and is aimed at land managers, access professionals, rangers, planners, surveyors, and community and interest groups involved in the development and management of outdoor access in Scotland.

www.pathsforall.org.uk/resource/outdoor-access-design-guide

Paths for All Access Guidance

Guidance on accessible practices, from routes to signage, community walking programmes and managing access in the countryside.

www.pathsforall.org.uk/resources

Out There

A sportscotland policy statement on sport and physical recreation in the outdoors.

www.sportscotland.org.uk/documents/resources/outthere_final.pdf

Signage Guidance for Outdoor Access

Planning for inclusive access in Wales: Good Practice Guidance Toolkit, Disability Wales/Anabledd Cymru.

www.pathsforall.org.uk/resource/signage-guidance-for-outdoor-access

Guidance written by Access Design Solutions for Disability Wales.

www.disabilitywales.org/wp-content/uploads/2018/03/WAY-TO-GO-Toolkit-E-with-links.pdf

Plain English Campaign

A-Z of alternative words to help produce clearer writing.

www.plainenglish.co.uk/A-Z.html

The Path Manager's Guide to Grading, Paths for All, NatureScot and Forestry and Land Scotland, 2016

The guide outlines a standard waymarked path grading system for Scotland, developed through extensive testing in Scotland. It addresses all aspects of planning and implementing the grading system.

www.pathsforall.org.uk/resource/the-path-managers-guide-to-grading

Scottish Access Technical Information Network (SATIN)

The network supports people in active travel and outdoor access to share technical access information and promote good practice.

www.satinonline.org/

Sensory Trust Access Guidance

Guidance on inclusive design and accessible practices, from paths and routes, to seating, play and interpretation, and inclusive community engagement.

www.sensorytrust.org.uk/resources/guidance

Signage Guidance for Outdoor Access – a Guide to Good Practice

Guidance on inclusive signage for outdoor sites and routes. Published by Paths for All and Scottish Natural Heritage (now NatureScot).

www.outdooraccess-scotland.scot/doc/signage-guidance-outdoor-access-guide-good-practice

The Sign Design Guide, a guide to inclusive signage. Peter Barker and June Fraser, Sign Design Society and RNIB.

Essential guidance for the development of clear signage and wayfinding. There is a new version of the guide in preparation, in the meantime the original guide is only available as hard copy.

www.signdesignsociety.co.uk/book/the-sign-design-guide/

Legislation and policy documents

Building Regulations 2015. Approved Document M: Access to and Use of Buildings. NBS (National Building Specifications), 2004 edition with 2010 changes.

www.planningportal.co.uk/applications/building-control-applications/building-control/approved-documents/part-m-access-to-and-use-of-buildings/approved-document-m-volume-2-buildings-other-than-dwellings

BS 8300-1:2018 Design of an accessible and inclusive built environment – external environment. Code of Practice. British Standards Institute.

www.shop.bsigroup.com/products/design-of-an-accessible-and-inclusive-built-environment-external-environment-code-of-practice/standard

BS 5709:2018. Gaps, gates and stiles. British Standards Institute.

www.shop.bsigroup.com/ProductDetail/?pid=000000000030359173

A guide by the Pittecroft Trust explaining the key rules of BS 5709:2018

www.centrewire.com/wp-content/uploads/2019/09/Pittecroft-Trust-BS5709-2018-explained.pdf

Community empowerment Act Scotland.

www.gov.scot/publications/community-empowerment-scotland-act-summary/

CRoW, the National Archives.

www.legislation.gov.uk/ukpga/2000/37/contents

Statutory legislation and HMSO documents.

www.legislation.gov.uk

Equality Act 2010 Code of Practice: Services, Public Functions and Associations Statutory Code of Practice. London: Equality and Human Rights Commission, 2011.

www.legislation.gov.uk/ukpga/2010/15/contents

Defra Good Practice Guidance on Public Path Structures – guidance for local authorities on compliance with the Equality Act 2010.

www.oss.org.uk/wp-content/uploads/2011/06/understandingdefrastructures3e20120702.pdf

National Planning Policy Framework. Department for Communities and Local Government, 2012.

www.planningguidance.planningportal.gov.uk/

National disability Strategy, UK Government.

www.gov.uk/government/publications/national-disability-strategy

Key contacts

Access to the outdoors and inclusive design

These national and regional organisations promote and support equality and diversity across the range of protected characteristics. They are valuable sources of guidance, examples of good practice and networks. These can also provide useful connections if you are planning community consultation and may be able signpost local groups and organisations.

General equality and diversity

UK government www.gov.uk/government/organisations/home-office/about/equality-and-diversity

Scottish parliament www.parliament.scot/about/working-for-the-scottish-parliament/equality-diversity-and-inclusion

Welsh government www.gov.wales/equality

Northern Ireland Assembly www.niassembly.gov.uk/

Diverse Cymru www.diversecymru.org.uk

Equality and Human Rights Commission

England www.equalityhumanrights.com/en

Northern Ireland www.nihrc.org/

Scotland www.equalityhumanrights.com/en/commission-scotland

Wales www.equalityhumanrights.com/en/commission-wales

NHS Equality and Human Rights

England www.england.nhs.uk/about/equality/

Health and Social Care Board Northern Ireland www.hscboard.hscni.net/about-us/equality-human-rights-and-diversity/

Scotland www.nes.scot.nhs.uk/about-us/equality-and-diversity/

Wales www.nwssp.nhs.wales/a-wp/governance-e-manual/living-public-service-values/equality-diversity-and-human-rights/

Age equality

Age UK www.ageuk.org.uk

Age NI www.ageuk.org.uk/northern-ireland/

Age Scotland www.ageuk.org.uk/scotland/

Age Cymru www.ageuk.org.uk/cymru

Children in Northern Ireland www.ci-ni.org.uk/

Children in Scotland www.childreninScotland.org.uk/

Children in Wales www.childreninwales.org.uk

Street Games www.streetgames.org

Disability equality, including dementia and mental health

Disability Rights UK www.disabilityrightsuk.org

Disability Equality Scotland www.disabilityequality.scot/

Disability Wales www.disabilitywales.org/

Equality Commission for Northern Ireland www.equalityni.org/Disability

Disabled Ramblers www.disabledramblers.co.uk/

Scope www.scope.org.uk/

Sense www.sense.org.uk

Assistance Dogs UK Information (ADUK) for Service Providers
www.assistancedogs.org.uk

Learning disabilities

Foundation for People with Learning Disabilities [www.mentalhealth.org.uk/
learning-disabilities](http://www.mentalhealth.org.uk/learning-disabilities)

Mencap www.mencap.org.uk

Mencap Cymru www.wales.mencap.org.uk/cy

Mencap Northern Ireland www.northernireland.mencap.org.uk/

Scottish Commission for People with Learning Disabilities www.sclld.org.uk/

Mental health

Action Mental Health www.amh.org.uk/

Mind www.mind.org.uk

Mind Cymru www.mind.org.uk/about-us/mind-cymru

SAMH (Scottish Association for Mental Health) www.samh.org.uk/

Change Mental Health Scotland www.changemh.org/

Mobility

Disability Sport Northern Ireland www.dsni.co.uk/

Whizz-kidz www.whizz-kidz.org.uk/

WheelPower www.wheelpower.org.uk/

Dementia

Alzheimer's Society www.alzheimers.org.uk

Alzheimer's Society Northern Ireland [www.alzheimers.org.uk/about-us/
northern-ireland](http://www.alzheimers.org.uk/about-us/northern-ireland)

Alzheimer Scotland www.alzscot.org/what-is-dementia

Alzheimer's Society Wales www.alzheimers.org.uk/about-us/wales

Dementia Adventure www.dementiaadventure.co.uk/

Innovations in Dementia www.innovationsindementia.org.uk/

Neurodiversity and acquired brain injury

Headway www.headway.org.uk/

Headway Northern Ireland www.headway.org.uk/supporting-you/in-your-area/groups-and-branches/northern-ireland/

Headway Scotland www.headway.org.uk/supporting-you/in-your-area/groups-and-branches/scotland/

Headway Wales www.headway.org.uk/supporting-you/in-your-area/groups-and-branches/wales/

Stroke Association www.stroke.org.uk

Neurodiversity and autism

National Autistic Society www.autism.org.uk

National Autistic Society Northern Ireland www.autism.org.uk/what-we-do/northern-ireland

National Autistic Society Scotland www.autism.org.uk/what-we-do/scotland

National Autistic Society Wales www.autism.org.uk/what-we-do/wales

Scottish Autism www.scottishautism.org

Sensory disabilities

RNIB (Royal National Institute of Blind People) www.rnib.org.uk

RNIB Northern Ireland www.rnib.org.uk/northern-ireland

RNIB Scotland www.rnib.org.uk/scotland

RNIB Wales www.rnib.org.uk/wales-cymru-1

RNID (Royal National Institute for Deaf People) www.rnid.org.uk/

RNID Northern Ireland www.rnid.org.uk/about-us/rnid-in-northern-ireland/

RNID Scotland www.rnid.org.uk/about-us/rnid-in-scotland/

RNID Wales www.rnid.org.uk/about-us/rnid-in-wales/

Deaf Scotland www.deafscotland.org/

Deaf Action: www.deafaction.org/

Deafblind Scotland: www.dbscotland.org.uk/

Gender equality

Chwarae Teg www.chwaraeteg.com/

Engender, Scotland www.engender.org.uk/

Gender Identity Research and Education Society www.gires.org.uk

Gendered Intelligence www.genderedintelligence.co.uk/index.html

LGBT Foundation www.lgbt.foundation/

LGBT Health and Wellbeing, Scotland www.lgbthealth.org.uk/

Scottish Trans Alliance www.scottishtrans.org/

Stonewall www.stonewall.org.uk

Unique Transgender www.uniquetg.org.uk

Women's Equality Network Wales www.wenwales.org.uk/

Equality in religion and belief

The interfaith network for the UK provides information about the traditions and practices of the different faith communities in the UK. It signposts national and regional groups and organisations www.interfaith.org.uk

Racial equality

Backbone www.backbone.uk.net/

Black Environment Network (BEN) www.ben-network.org.uk

Coalition for Racial Equality and Rights, Scotland www.crer.scot/

Displaced People in Action (DPIA) www.dpia.org.uk

Race Council Cymru www.racecouncilcymru.org.uk/

Race Equality Foundation www.raceequalityfoundation.org.uk

Race Equality First www.raceequalityfirst.org/

Outdoor access advice and guidance

Accessible Countryside for Everyone www.accessiblecountryside.org.uk

Accessible Outdoors - Disability Information Scotland www.disabilityscot.org.uk

Black Environment Network www.ben-network.org.uk/

Centre for Accessible Environments www.cae.org.uk

Centrewire (specialist gates) www.centrewire.com/

Changing Places www.changing-places.org/

Countryside Mobility www.countrysidemobility.org/ (south west England)

Heritage Ability www.countrysidemobility.org/heritage-ability/ha-vision

Design Council www.designcouncil.org.uk/

Disabled Ramblers www.disabledramblers.co.uk/

Euan's Guide www.euansguide.com/

Experience Community www.experiencecommunity.co.uk/

Health and Safety Executive www.hse.gov.uk
Historic England www.historicengland.org.uk/
Historic Environment Scotland www.historicenvironment.scot
Mind www.mind.org.uk
National Register of Access Consultants www.nrac.org.uk
Natural Resources Wales www.naturalresources.wales
Open Spaces Society www.oss.org.uk
Open Space research [www.openspace.eca.ed.ac.uk/research-projects/
inclusive-design-for-getting-outdoors](http://www.openspace.eca.ed.ac.uk/research-projects/inclusive-design-for-getting-outdoors)
Partnership on Health and Safety in Scotland [www.hse.gov.uk/scotland/
partnership.htm#:~:text=The%20Partnership%20on%20Health%20
and,health%20and%20safety%20in%20Scotland](http://www.hse.gov.uk/scotland/partnership.htm#:~:text=The%20Partnership%20on%20Health%20and,health%20and%20safety%20in%20Scotland)
Paths for All www.pathsforall.org.uk/
Play England www.playengland.org.uk
Ramblers www.ramblers.org.uk
RNIB www.rnib.org.uk
Scope www.scope.org.uk
Sensory Trust www.sensorytrust.org.uk
Sustrans www.sustrans.org.uk/
Thrive www.thrive.org.uk
Tourism for All www.tourismforall.org.uk
Visit Britain www.visitbritain.com
Visit Scotland www.visitscotland.com/
Visitor Safety in the Countryside Group www.visitorsafety.group/
Web Accessibility Initiative www.w3.org/wai
Widgit www.widgit.com/
Sport England www.sportengland.org/
Sportscotland www.sportscotland.org.uk/

Environmental organisations and diversity

English Heritage www.english-heritage.org.uk/
Environment Agency [www.gov.uk/government/organisations/environment-
agency](http://www.gov.uk/government/organisations/environment-agency)
Forestry and Land Scotland www.forestryandland.gov.scot/
Scottish Forestry www.forestry.gov.scot/
Forestry England www.forestryengland.uk/

National Trust www.nationaltrust.org.uk/

National Trust for Scotland www.nts.org.uk/

Natural England www.gov.uk/government/organisations/natural-england

Natural Resources Wales www.naturalresources.wales/

NatureScot www.nature.scot/

Woodland Trust www.woodlandtrust.org.uk/